

OPTIDRIVE™ elevaTOR

AC Variable Speed Drive for Control of Geared and Gearless Elevator Motors.

200-240 Volt 1 Phase
0.75kW – 2.2kW / 1HP – 3HP

200-240 Volt 3 Phase
380 – 480 Volt 3 Phase
4kW – 37kW / 5HP – 50HP

Installation & Operating Instructions



Declaration of Conformity

Invertek Drives Limited
Offas Dyke Business Park
Welshpool
Powys, UK
SY21 8JF

Invertek Drives Ltd hereby states that the Optidrive ODP-2 product range conforms to the relevant safety provisions of the following council directives:

2014/30/EU (EMC) and 2014/35/EU (LVD)

Design and manufacture is in accordance with the following harmonised European standards:

EN 61800-5-1: 2007+A1:2017	Adjustable speed electrical power drive systems. Safety requirements. Electrical, thermal and energy.
EN 61800-3 : 2004/A1 2012	Adjustable speed electrical power drive systems. EMC requirements and specific test methods
EN 55011: 2007	Limits and Methods of measurement of radio disturbance characteristics of industrial, scientific and medical (ISM) radio-frequency equipment (EMC)
EN60529 : 1992	Specifications for degrees of protection provided by enclosures

Safe Torque Off (“STO”) Function

Optidrive P2 incorporates a hardware “Safe Torque Off” Function, designed in accordance with the standards listed below.

Standard	Classification	Independent Approval
EN 61800-5-2:2016	Type 2	*TUV
EN ISO 13849-1:2015	PL “d”	
EN 61508 (Part 1 to 7):2010	SIL 2	
EN 60204-1:2006+A1:2009+AC:2010	Uncontrolled Stop “Category 0”	
EN 62061:2005/A2:2015	SIL CL2	

*Note: TUV Approval of the “STO” function is relevant for drives which have a TUV logo applied on the drive rating label.

Electromagnetic Compatibility

All Optidrive P2 drives are designed with high standards of EMC in mind. All versions suitable for operation on Single Phase 230 volt and Three Phase 400 volt supplies and intended for use within the European Union are fitted with an internal EMC filter. This EMC filter is designed to reduce the conducted emissions back into the supply via the power cables for compliance with harmonised European standards.

It is the responsibility of the installer to ensure that the equipment or system into which the product is incorporated complies with the EMC legislation of the country of use. Within the European Union, equipment into which this product is incorporated must comply with the EMC Directive 2004/108/EC. When using an Optidrive P2 with an internal or optional external filter, compliance with the following EMC Categories, as defined by EN61800-3:2004 can be achieved:

Drive Type / Rating	EMC Category – Conducted Emissions		
	Cat C1	Cat C2	Cat C3
1 Phase, 230 Volt Input ODL-2-x2xxx-xxBxx	No additional filtering required Installation should be in accordance with Good EMC Practice (Refer to section 6.1)		
3 Phase, 400 Volt Input ODL-2-x4xxx-xxAxx	Use External Filter OD-Fx34x	No additional filtering required Installation in accordance with Good EMC Practice (Refer to section 6.1)	
Note	Compliance with EMC standards is dependent on a number of factors including the environment in which the drive is installed, motor switching frequency, motor, cable lengths and installation methods adopted.		
	For motor cable lengths greater than 100m, an output dv / dt filter must be used, please refer to the Invertek Stock Drives Catalogue for further details		
	Vector Speed mode may not operate correctly with long motor cables and output filters. It is recommended to operate in V/F mode for cable lengths exceeding 50m		

All rights reserved. No part of this User Guide may be reproduced or transmitted in any form or by any means, electrical or mechanical including photocopying, recording or by any information storage or retrieval system without permission in writing from the publisher.

Copyright Invertek Drives Ltd © 2020

All Invertek Optidrive P2 units carry a 2 year warranty against manufacturing defects from the date of manufacture. The manufacturer accepts no liability for any damage caused during or resulting from transport, receipt of delivery, installation or commissioning. The manufacturer also accepts no liability for damage or consequences resulting from inappropriate, negligent or incorrect installation, incorrect adjustment of the operating parameters of the drive, incorrect matching of the drive to the motor, incorrect installation, unacceptable dust, moisture, corrosive substances, excessive vibration or ambient temperatures outside of the design specification.

The local distributor may offer different terms and conditions at their discretion, and in all cases concerning warranty, the local distributor should be contacted first.

This user guide is the “original instructions” document. All non-English versions are translations of the “original instructions”.

The contents of this User Guide are believed to be correct at the time of printing. In the interest of a commitment to a policy of continuous improvement, the manufacturer reserves the right to change the specification of the product or its performance or the contents of the User Guide without notice. This User Guide is for use with version **2.30** or later Firmware.

Invertek Drives Ltd adopts a policy of continuous improvement and whilst every effort has been made to provide accurate and up to date information, the information contained in this User Guide should be used for guidance purposes only and does not form the part of any contract.





1. Introduction	5
1.1. Important safety information	5
2. Electrical Installation quick reference	6
3. Optidrive P2 Elevator Features and Functions	7
4. Product Ratings	8
4.1. Drive model numbers.....	8
5. Mechanical Installation	9
5.1. General.....	9
5.2. Routine Maintenance.....	9
5.3. UL Compliant Installation.....	9
5.4. Mechanical dimensions and weights	9
5.5. Guidelines for Enclosure mounting.....	10
5.6. Mounting the Drive.....	10
6. Electrical Installation	11
6.1. Installation in accordance with Good EMC Practice	11
6.2. Grounding the Drive.....	12
6.3. Electrical Connections (Mains Side)	13
6.4. Electrical Connections (Brake Resistor).....	14
6.5. Electrical Connections (Motor Side).....	15
6.6. Motor Thermal overload Protection	15
6.7. Control Terminal Wiring.....	16
6.8. Control Terminals Connection Diagram	16
6.9. Control Terminal Connections	16
6.10. Control Terminal Configuration	17
6.11. Motor Contactor Control	17
6.12. Motor Holding Brake Control.....	18
7. Safe Torque Off	20
7.1. Safe Torque Off	20
8. Optional Encoder Interface modules	24
8.1. Encoder interface module Mechanical Installation	24
8.2. Encoder interface module electrical installation	24
8.3. Encoder interface module parameter setup.....	24
9. Managing the Keypad	25
9.1. Keypad Layout and Function – Standard LED Keypad.....	25
9.2. Changing Parameters	25
9.3. Advanced Keypad Operation Short Cuts.....	26
9.4. Drive Operating Displays.....	26
9.5. Resetting Parameters to Factory Default Settings	27
9.6. Resetting Parameters to User Default Settings	27
9.7. Elevator Specific Linear Units.....	27
10. Start up and Commissioning	28
Commissioning flow diagram.....	28
10.1. Motor Operating Modes.....	29
11. First Start-up of Geared (Induction) Motors.	30
11.1. Step 1- Wiring Connections.....	30
11.2. Step 2- Pre-Power Checks	31
11.3. Step 3- Apply Power.....	32
11.4. Step 4- Motor nameplate data entry	32
11.5. Step 5- Motor Auto-tune	32
11.6. Step 6 - Encoder Setup (If Encoder is installed)	33
11.7. Enhanced V/F motor Control	34
12. Start-up of Gearless (Permanent Magnet) Motor-With Encoder Feedback.	35
12.1. Step 1- Wiring Connections.....	35
12.2. Step 2- Pre-Power Checks	36
12.3. Step 3- Apply Power.....	37
12.4. Step 4- Motor nameplate data entry	37
12.5. Step 5- Motor Auto-tune	38
12.6. Step 6- Encoder setup	38
12.7. Step 7a- Stationary Encoder offset measurement (Alternative to rotating measurement)	39
12.8. Step 7b - Rotating Encoder offset measurement (Alternative to Stationary measurement)	40
13. Comfort Optimisation	41

13.1.	Ramp and travel Jerk Adjustment diagram.....	41
13.2.	Speed Loop Gains.....	41
13.3.	Comfort Optimisation Procedure.....	43
	The below guidance assumes that steps 1 thru to 6 in section 11(Geared)/12 (Gearless) have already been performed.....	43
14.	Advanced Features.....	45
14.1.	Short Floor Operation	45
14.2.	Rescue Mode Operation (UPS Power Supply).....	46
14.3.	Motor presence check before opening mechanical brake.....	47
14.4.	Motor brake release monitoring.....	48
15.	Gearless (Permanent Magnet) Motors-Without Encoder (P4-01=3).....	49
15.1.	Step 1- Wiring Connections.....	49
15.2.	Step 2- Pre-Power Checks.....	49
15.3.	Step 3- Apply Power.....	49
15.4.	Step 4- Motor nameplate data entry.....	49
15.5.	Step 5- Motor Auto-tune.....	50
16.	Parameters.....	51
16.1.	Parameter Set Overview	51
16.2.	Parameter Group 1 – Speed Limits, Basic motor data, Command Source.....	51
16.3.	Parameter Group 2 – Travel Speeds, I/O setup.....	52
16.4.	Parameter Group 3 – S-ramps, Output contactor/Brake, Short floor, Light load detection.....	55
16.5.	Parameter Group 4 –Motor Control modes, Speed Loop Gains, Current limits.....	56
16.6.	Parameter Group 5 – Modbus, CAN Open Communication.....	57
16.7.	Parameter Group 6: Encoder setup, Brake Release Monitoring.....	58
16.8.	Parameter Group 7: Motor measured data, Rollback control gains.....	59
16.9.	Group 8 and Group 9: Refer to Optitools studio commissioning tool.....	60
16.10.	Parameter Group 0 – Monitoring Parameters (Read Only).....	60
17.	Serial communications.....	62
17.1.	RS-485 communications.....	62
17.2.	Modbus RTU Communications	62
18.	Technical Data.....	64
18.1.	Environmental.....	64
18.2.	Input voltage ranges	64
18.3.	Output Power and Current ratings	65
18.4.	Additional Information for UL Approved Installations.....	66
18.5.	Derating Information	67
18.6.	Energy Efficiency Classification	67
19.	Troubleshooting.....	68
19.1.	Fault messages	68
20.	User Settings Table.....	70
21.	Quick Reference Sheet	72
21.1.	Terminal Functions (default Settings).....	72
21.2.	Speed Profile setup.....	72

1. Introduction

1.1. Important safety information

Please read the **IMPORTANT SAFETY INFORMATION** below, and all **Warning and Caution** information elsewhere.

	Danger: Indicates a risk of electric shock, which, if not avoided, could result in damage to the equipment and possible injury or death.		Danger: Indicates a potentially hazardous situation other than electrical, which if not avoided, could result in damage to property.
	This variable speed drive product (Optidrive P2 Elevator) is intended for professional incorporation into complete equipment or systems as part of a fixed installation. If installed incorrectly it may present a safety hazard. The drive uses high voltages and currents, carries a high level of stored electrical energy, and is used to control mechanical plant that may cause injury. Close attention is required to system design and electrical installation to avoid hazards in either normal operation or in the event of equipment malfunction. Only qualified electricians are allowed to install and maintain this product.		
	System design, installation, commissioning and maintenance must be carried out only by personnel who have the necessary training and experience. They must carefully read this safety information and the instructions in this Guide and follow all information regarding transport, storage, installation and use of the drive, including the specified environmental limitations.		
	Do not perform any flash test or voltage withstand test on the Optidrive P2 Elevator drive. Any electrical measurements required should be carried out with the drive disconnected.		
	Electric shock hazard! Disconnect and ISOLATE the Optidrive P2 Elevator drive before attempting any work on it. High voltages are present at the terminals and within the drive for up to 10 minutes after disconnection of the electrical supply. Always ensure by using a suitable multimeter that no voltage is present on any drive power terminals prior to commencing any work.		
	Where supply to the drive is through a plug and socket connector, do not disconnect until 10 minutes have elapsed after turning off the supply.		
	Ensure correct earthing connections. The earth cable must be sufficient to carry the maximum supply fault current which normally will be limited by the fuses or MCB. Suitably rated fuses or MCB should be fitted in the mains supply to the drive, according to any local legislation or codes.		
	Do not carry out any work on the drive control cables whilst power is applied to the drive or to the external control circuits.		
	The "Safe Torque Off" Function does not prevent high voltages from being present at the drives power terminals.		
	Within the European Union, all machinery in which this product is used must comply with the machinery directive 2006/42/EC. In particular, the machine manufacturer is responsible for providing a main switch and ensuring the electrical equipment complies with EN60204-1.		
	The level of integrity offered by the Optidrive P2 Elevator control input functions (excluding the 'Safe Torque OFF Input') – for example stop/start, forward/reverse and maximum speed is not sufficient for use in safety-critical applications without independent channels of protection. All applications where malfunction could cause injury or loss of life must be subject to a risk assessment and further protection provided where needed.		
	The driven motor can start at power up if the enable input signal is present.		
	The STOP function does not remove potentially lethal high voltages. ISOLATE the drive and wait 10 minutes before starting any work on it. Never carry out any work on the Drive, Motor or Motor cable whilst the input power is still applied.		
	The Optidrive P2 Elevator drive can be programmed to operate the driven motor at speeds above or below the speed achieved when connecting the motor directly to the mains supply. Obtain confirmation from the manufacturers of the motor and the driven machine about suitability for operation over the intended speed range prior to machine start up.		
	Do not activate the automatic fault reset function on any systems whereby this may cause a potentially dangerous situation.		
	The Optidrive P2 Elevator drive has an Ingress Protection rating of IP20 and must be installed in a suitable enclosure.		
	The Optidrive P2 Elevator drive is intended for indoor use only.		
	When mounting the drive, ensure that sufficient cooling is provided. Do not carry out drilling operations with the drive in place, dust and swarf from drilling may lead to damage.		
	The entry of conductive or flammable foreign bodies should be prevented. Flammable material should not be placed close to the drive		
	Relative humidity must be less than 95% (non-condensing).		
	Ensure that the supply voltage, frequency and no. of phases (1 or 3 phase) correspond to the rating of the Optidrive P2 Elevator drive as delivered.		
	Never connect the mains power supply to the Output terminals U, V, W.		
	Do not install any type of automatic switchgear between the drive and the motor		
	Wherever control cabling is close to power cabling, maintain a minimum separation of 100 mm and arrange crossings at 90 degrees. Ensure that all terminals are tightened to the appropriate torque setting		
	Do not attempt to carry out any repair of the drive. In the case of suspected fault or malfunction, contact your local Invertek Drives Sales Partner for further assistance.		

2. Electrical Installation quick reference

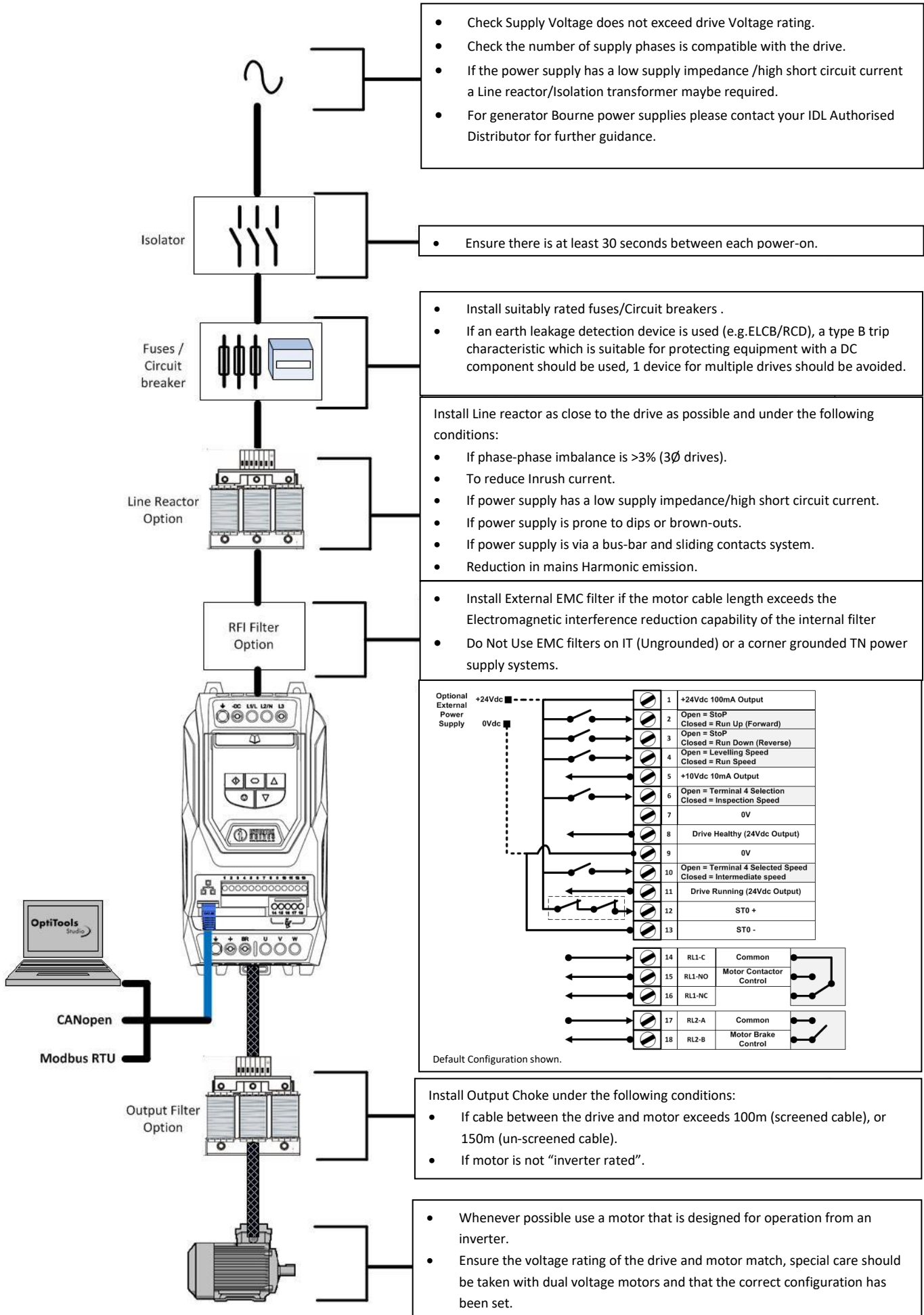

3. Optidrive P2 Elevator Features and Functions

The Diagram below illustrates a typical Elevator drive system and the available solutions using the Optidrive P2 Elevator drive.

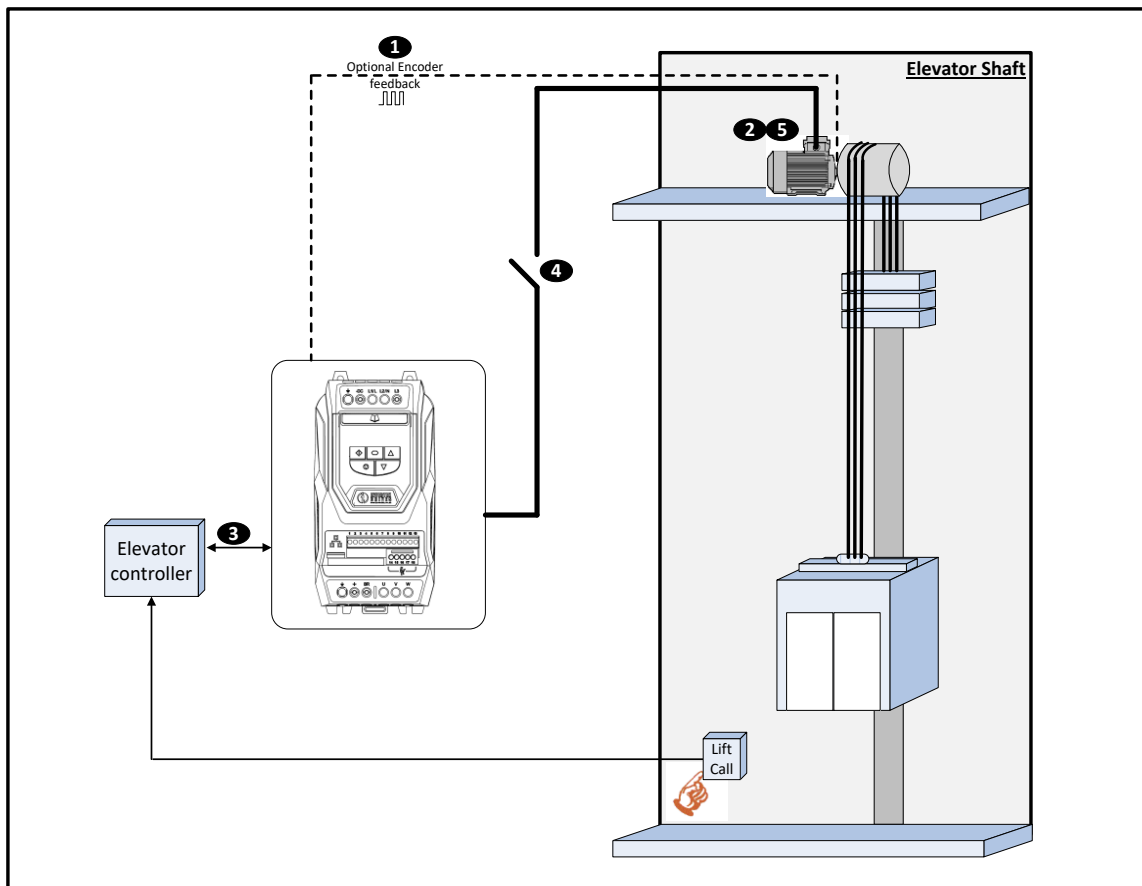

Feature/Function	Section	Notes
1 Encoder : <ul style="list-style-type: none"> Incremental Absolute Endat/SinCos (With simulated Encoder Output) 	8	With Expansion Module <ul style="list-style-type: none"> OPT-2-ENCOD/OPT-2-ENCHT-IN OPT-2-ENDAT2-IN / OPT-2-SINCOS2-IN
2 Geared (Induction Motor Control) : <ul style="list-style-type: none"> Open Loop Enhanced V/F Open Loop Vector Closed Loop Vector Gearless (Permanent Magnet) : <ul style="list-style-type: none"> Closed Loop Vector *Open Loop Vector 	10.1	*PM Open Loop Vector control with Limitations (Motor dependant), contact Invertek Technical/product support for further information.
3 Built-in Communications Interface <ul style="list-style-type: none"> CANopen Modbus RTU 	17.1	
Safe Torque Off Input	7	
Built-in Dynamic Braking	6.4	Dynamic braking Automatically Enabled. Brake Resistor overload protection can optionally be enabled.
Rotating or Stationary Encoder offset measurement	12.7 12.8	
Rollback compensation	13.2.3	Car floor position holding when brake is released.
4 Motor Contactor Control	6.11	If required the drive can control the motor contactor operation, furthermore the drive output signal can be optimally delayed to prevent nuisance drive trips, and contactor/motor wear.
5 Motor Brake Control	6.12	
Brake Release Monitoring	14.4	In accordance with En81-20:2014 (Protection against unintended car movement).
5 independent s-ramps/Jerk Adjustments	13.1	
Short Floor Operation	14.1	
Rescue Mode operation with Light Load Detection	14.2	UPS 240V single phase.
Elevator programmable user units	9.7	

4. Product Ratings

4.1. Drive model numbers

200-240V ±10% - 1 Phase Input					
kW Model Number	kW	HP Model Number	HP	Output Current (A)	Frame Size
With Filter		With Filter			
ODL-2-22075-1KF42-SN	0.75	ODL-2-22010-1HF42-SN	1	4.3	2
ODL-2-22150-1KF42-SN	1.5	ODL-2-22020-1HF42-SN	2	7	2
ODL-2-22220-1KF42-SN	2.2	ODL-2-22030-1HF42-SN	3	10.5	2

200-240V ±10% - 3 Phase Input					
kW Model Number	kW	HP Model Number	HP	Output Current (A)	Frame Size
With Filter		With Filter			
ODL-2-32040-3KF42-SN	4	ODL-2-32050-3HF42-SN	5	18	3
ODL-2-32055-3KF42-SN	5.5	ODL-2-32075-3HF42-SN	7.5	24	3
ODL-2-42075-3KF42-TN	7.5	ODL-2-42100-3HF42-TN	10	30	4
ODL-2-42110-3KF42-TN	11	ODL-2-42150-3HF42-TN	15	46	4
ODL-2-52150-3KF42-TN	15	ODL-2-52020-3HF42-TN	20	61	5
ODL-2-52185-3KF42-TN	18.5	ODL-2-52025-3HF42-TN	25	72	5

380-480V ±10% - 3 Phase Input					
kW Model Number	kW	HP Model Number	HP	Output Current (A)	Frame Size
With Filter		With Filter			
ODL-2-24400-3KF42-SN	4	ODL-2-24050-3HF42-SN	5	9.5	2
ODL-2-34055-3KF42-SN	5.5	ODL-2-34075-3HF42-SN	7.5	14	3
ODL-2-34075-3KF42-SN	7.5	ODL-2-34100-3HF42-SN	10	18	3
ODL-2-34110-3KF42-SN	11	ODL-2-34150-3HF42-SN	15	24	3
ODL-2-44150-3KF42-TN	15	ODL-2-44200-3HF42-TN	20	30	4
ODL-2-44185-3KF42-TN	18.5	ODL-2-44250-3HF42-TN	25	39	4
ODL-2-44220-3KF42-TN	22	ODL-2-44300-3HF42-TN	30	46	4
ODL-2-54300-3KF42-TN	30	ODL-2-54040-3HF42-TN	40	61	5
ODL-2-54370-3KF42-TN	37	ODL-2-54050-3HF42-TN	50	72	5

5. Mechanical Installation

5.1. General

- The Optidrive P2 Elevator drive should be mounted in a vertical position only, on a flat, flame resistant, vibration free mounting using the integral mounting holes or DIN Rail clip (Frame Size 2 only).
- The Optidrive P2 Elevator drive must be installed in a pollution degree 1 or 2 environment only.
- Do not mount flammable material close to the Optidrive P2 Elevator drive.
- Ensure that the minimum cooling air gaps, as detailed in section 5.5 and **Error! Reference source not found.** are left clear
- Ensure that the ambient temperature range does not exceed the permissible limits for the Optidrive P2 Elevator drive given in section 18.1
- Provide suitable clean, moisture and contaminant free cooling air sufficient to fulfil the cooling requirements of the Optidrive P2 Elevator drive.
- Before Installation check the drive rating label to ensure it is of the correct type and power requirements for the application.
- Carefully Unpack the Optidrive P2 Elevator drive and check for any signs of damage. Notify the shipper immediately if any exist.
- Store the Optidrive P2 Elevator drive in its original box until required. Storage should be clean and dry and within the temperature range -40°C to +60°C

5.2. Routine Maintenance

The drive should be included within the scheduled maintenance program so that the installation maintains a suitable operating environment, this should include:

- Ambient temperature is within the temperature range as set out in the “Environmental” section 18.1.
- Heat sink fans freely rotating and dust free.
- The Enclosure in which the drive is installed should be free from dust and condensation; furthermore ventilation fans and air filters should be checked for correct air flow.

Checks should also be made on all electrical connections, ensuring screw terminals are correctly torqued; and that power cables have no signs of heat damage.

5.3. UL Compliant Installation

Note the following for UL-compliant installation:

- The drive can be operated within an ambient temperature range as stated in section 18.1
- For IP20 units, installation is required in a pollution degree 1 environment
- UL Listed ring terminals / lugs must be used for all bus bar and grounding connections

5.4. Mechanical dimensions and weights

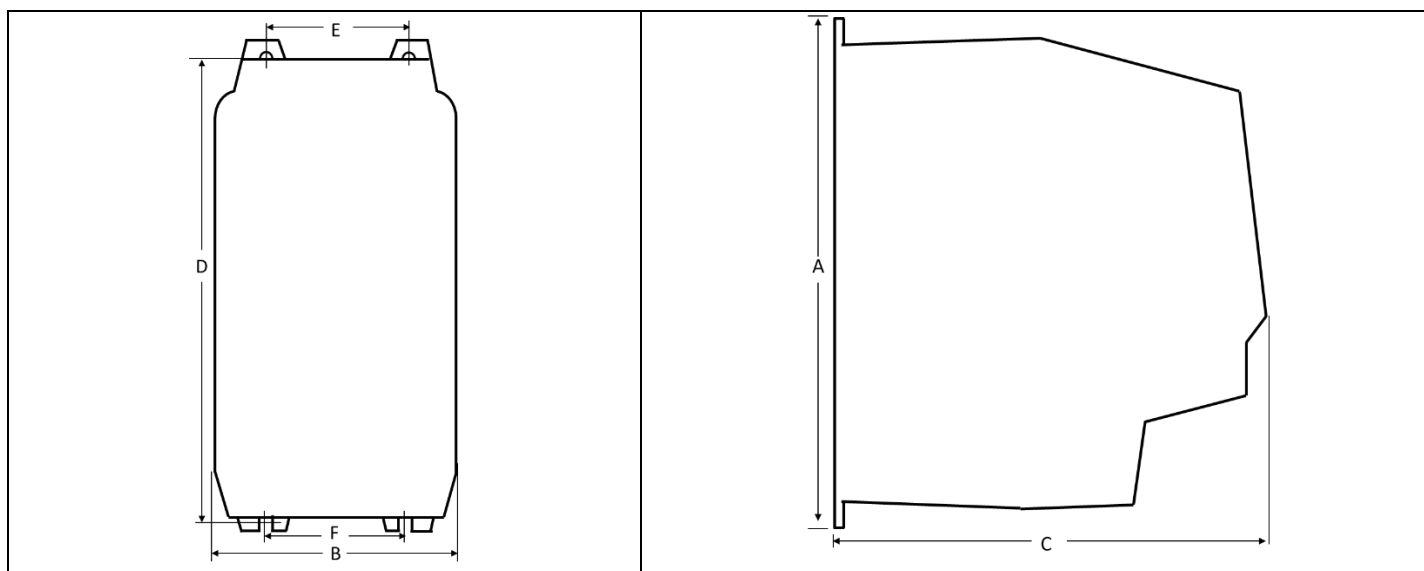

Drive Size	A		B		C		D		E		F		Weight	
	mm	in	mm	in	mm	in	mm	in	mm	in	mm	in	Kg	lb
2	221	8.70	110	4.33	185	7.28	209	8.23	63	2.48	63	2.48	1.8	4.0
3	261	10.28	131	5.16	205	8.07	247	9.72	80	3.15	80	3.15	3.5	7.7
4	418	16.46	160	6.30	240	9.45	400	15.75	125	4.92	125	4.92	9.2	20.3
5	486	19.13	222	8.74	260	10.24	460	18.11	175	6.89	175	6.89	18.1	39.9

Mounting Bolts			Tightening Torques			
Frame Size	Metric	UNF	Frame Size		Required Torque	
2	M4	#8	Control Terminals	All	0.5 Nm	4.5 lb-in
3	M4	#8		2 & 3	1 Nm	9 lb-in
4	M8	5/16	Power Terminals	4	2 Nm	18 lb-in
5	M8	5/16		5	4 Nm	35.5 lb-in

5.5. Guidelines for Enclosure mounting

- Installation should be in a suitable enclosure, according to EN60529 or other relevant local codes or standards.
- Enclosures should be made from a thermally conductive material.
- Where vented enclosures are used, there should be venting above the drive and below the drive to ensure good air circulation – see the diagram below. Air should be drawn in below the drive and expelled above the drive.
- In any environments where the conditions require it, the enclosure must be designed to protect the Optidrive P2 Elevator drive against ingress of airborne dust, corrosive gases or liquids, conductive contaminants (such as condensation, carbon dust, and metallic particles) and sprays or splashing water from all directions.
- High moisture, salt or chemical content environments should use a suitably sealed (non-vented) enclosure.

The enclosure design and layout should ensure that the adequate ventilation paths and clearances are left to allow air to circulate through the drive heatsink. Inverter Drives recommend the following minimum clearances for drives mounted in non-ventilated metallic enclosures:-

Drive Size	X Above & Below		Y Either Side		Z Between		Recommended airflow
	mm	in	mm	in	mm	in	
2	75	2.95	50	1.97	46	1.81	11
3	100	3.94	50	1.97	52	2.05	26
4	200	7.87	10	0.39	32	1.26	62
5	200	7.87	10	0.39	50	1.97	105

Note :
Dimension Z assumes that the drives are mounted side-by-side with no clearance.

Typical drive heat losses are 3% of operating load conditions.

Above are guidelines only and the operating ambient temperature of the drive **MUST** be maintained at all times.

5.6. Mounting the Drive

1. IP20 Units are intended for installation within a control cabinet.
2. When mounting with screws
 - Using the drive as a template, or the dimensions shown above, mark the locations for drilling
 - Ensure that when mounting locations are drilled, the dust from drilling does not enter the drive
 - Mount the drive to the cabinet backplate using suitable M5 mounting screws
 - Position the drive, and tighten the mounting screws securely
3. When Din Rail Mounting (Frame Size 2 Only)
 - Locate the DIN rail mounting slot on the rear of the drive onto the top of the DIN rail first
 - Press the bottom of the drive onto the DIN rail until the lower clip attaches to the DIN rail
 - If necessary, use a suitable flat blade screw driver to pull the DIN rail clip down to allow the drive to mount securely on the rail
 - To remove the drive from the DIN rail, use a suitable flat blade screwdriver to pull the release tab (as shown in the diagram above) downwards, and lift the bottom of the drive away from the rail.

6. Electrical Installation

- 

This manual is intended as a guide for proper installation. Invertek Drives Ltd cannot assume responsibility for the compliance or the non-compliance to any code, national, local or otherwise, for the proper installation of this drive or associated equipment. A hazard of personal injury and/or equipment damage exists if codes are ignored during installation.
- 

This Optidrive P2 Elevator drive contains high voltage capacitors that take time to discharge after removal of the main supply. Before working on the drive, ensure isolation of the main supply from line inputs. Wait ten (10) minutes for the capacitors to discharge to safe voltage levels. Failure to observe this precaution could result in severe bodily injury or loss of life.
- 

Only qualified electrical personnel familiar with the construction and operation of this equipment and the hazards involved should install, adjust, operate, or service this equipment. Read and understand this manual and other applicable manuals in their entirety before proceeding. Failure to observe this precaution could result in severe bodily injury or loss of life.

6.1. Installation in accordance with Good EMC Practice

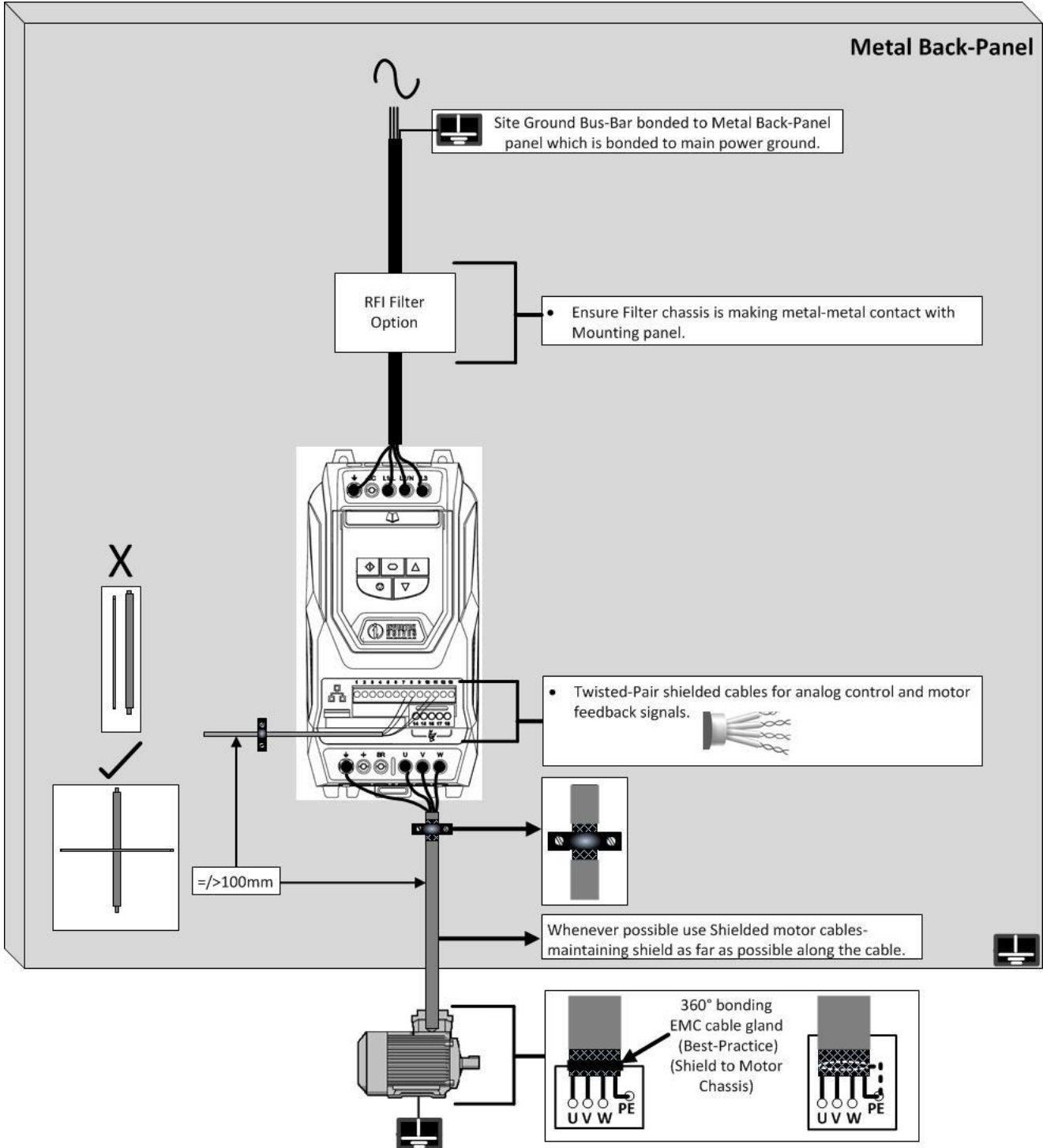

6.2. Grounding the Drive

6.2.1. Grounding Guidelines

The ground terminal of each Optidrive P2 Elevator drive should be individually connected DIRECTLY to the site ground bus bar (through the filter if installed). Optidrive P2 Elevator drive ground connections should not loop from one drive to another, or to, or from any other equipment. Ground loop impedance must conform to local industrial safety regulations. To meet UL regulations, UL approved ring crimp terminals should be used for all ground wiring connections.

The drive Safety Ground must be connected to system ground. Ground impedance must conform to the requirements of national and local industrial safety regulations and/or electrical codes. The integrity of all ground connections should be checked periodically.

6.2.2. Protective Earth Conductor

The Cross sectional area of the PE Conductor must be at least equal to that of the incoming supply conductor.

6.2.3. Safety Ground

This is the safety ground for the drive that is required by code. One of these points must be connected to adjacent building steel (girder, joist), a floor ground rod, or bus bar. Grounding points must comply with national and local industrial safety regulations and/or electrical codes.

6.2.4. Motor Ground

The motor ground must be connected to one of the ground terminals on the drive.

6.2.5. Ground Fault Monitoring

As with all inverters, a leakage current to earth can exist. The Optidrive P2 Elevator drive is designed to produce the minimum possible leakage current whilst complying with worldwide standards. The level of current is affected by motor cable length and type, the effective switching frequency, the earth connections used and the type of RFI filter installed. If an ELCB (Earth Leakage Circuit Breaker) is to be used, the following conditions apply: -

- A Type B Device must be used
- The device must be suitable for protecting equipment with a DC component in the leakage current
- Individual ELCBs should be used for each Optidrive P2 Elevator drive.

6.3. Electrical Connections (Mains Side)

6.3.1. Mains Power Connections

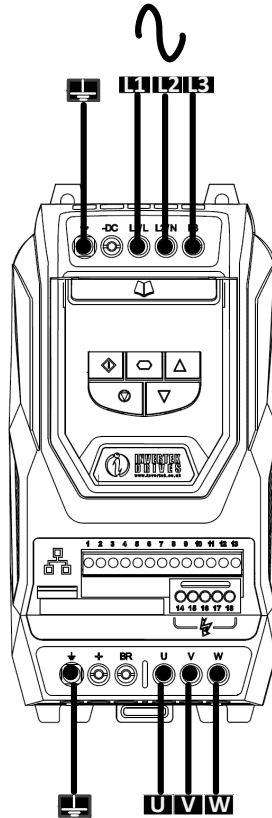

1. A fixed installation is required according to IEC61800-5-1 with a suitable disconnecting device installed between the Optidrive P2 Elevator drive and the AC Power Source. The disconnecting device must conform to the local safety code / regulations (e.g. within Europe, EN60204-1, Safety of machinery).
 2. Where allowed by local regulations, suitably dimensioned type B MCB circuit breakers of equivalent rating may be utilised in place of fuses, providing that the clearing capacity is sufficient for the installation.
 3. The maximum permissible short circuit current at the Optidrive P2 Elevator drive Power terminals as defined in IEC60439-1 is 100kA.
 4. When the power supply is removed from the drive, a minimum of 30 seconds should be allowed before re-applying the power. A minimum of 10 minutes should be allowed before removing the terminal covers or connection.
- An optional Input Choke is recommended to be installed in the supply line for drives where any of the following conditions occur:-
 - The incoming supply impedance is low or the fault level / short circuit current is high
 - The supply is prone to dips or brown outs
 - An imbalance exists on the supply (3 phase drives)
 - The power supply to the drive is via a busbar and brush gear system.
 - In all other installations, an input choke is recommended to ensure protection of the drive against power supply faults. Part numbers are shown in the table.

6.3.2. Input Chokes

Supply	Drive Power Rating (kW)	AC Input Inductor
230 Volt 1 Phase	0.75 / 1.5 / 2.2	OPT-2-L1025-20
230 Volt 3 Phase	4/5.5 / 7.5	OPT-2-L3036-20
	11	OPT-2-L3050-20
	15 / 18.5 / 22	OPT-2-L3090-20
	30 / 37	OPT-2-L3200-20
400 Volt 3 Phase	4	OPT-2-L3010-20
	5.5 / 7.5 / 11	OPT-2-L3036-20
	15 / 18.5 / 22	OPT-2-L3050-20
	30 / 37	OPT-2-L3090-20

6.3.3. Cables

- For compliance with CE and C Tick EMC requirements, a symmetrical shielded cable is recommended.
- It is recommended that the power cabling should be 4-core PVC-insulated screened cable, and laid in accordance with local industrial regulations and codes of practice
- The cables should be dimensioned according to any local codes or regulations. Guideline dimensions are given in section 18.3
- Suitable fuses to provide wiring protection of the input power cable should be installed in the incoming supply line, according to the data in section 18.3. The fuses must comply with any local codes or regulations in place. In general, type gG (IEC 60269) or UL type T fuses are suitable; however in some cases type aR fuses may be required. The operating time of the fuses must be below 0.5 seconds.

6.4. Electrical Connections (Brake Resistor)

The drive has an internal brake transistor fitted as standard and is enabled automatically when the regenerative energy from the load raises the drives internal DC bus to 390Vdc for the single and three phase 230V drives and 780Vdc for the 3 phase 400V drive.

6.4.1. Connecting the brake resistor

The brake resistor should be connected between the +/+DC and BR Terminals of the drive as shown in the images below.

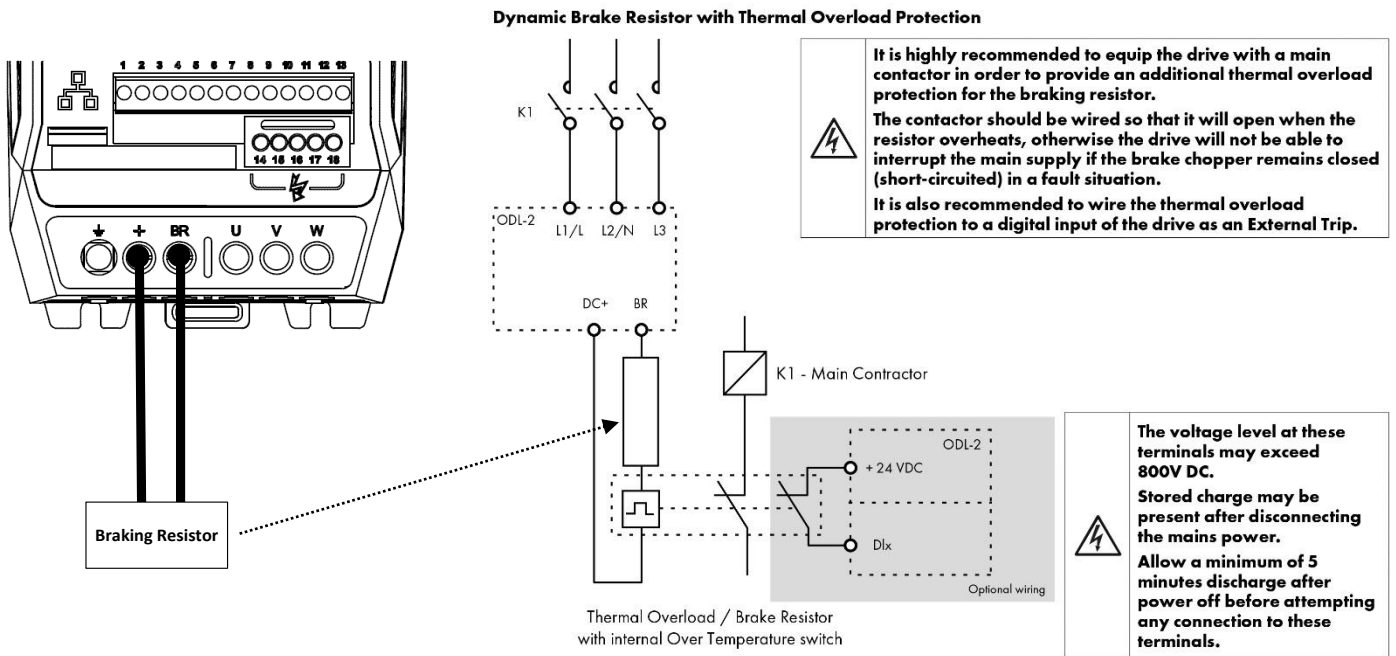

6.4.2. Brake resistor overload protection



From defaults the brake resistor overload protection is disabled.

Providing the correct values have been entered into parameters P3-13 and P3-14 the drive will protect the brake resistor against overload.

For correct protection:

- Enter the resistance of the brake resistor in P3-13 (Ohms)
- Enter the power of the brake resistor in P3-14 (kW)

6.5. Electrical Connections (Motor Side)

6.5.1. Cables

- The motor should be connected to the Optidrive P2 Elevator drive U, V, and W terminals using a suitable 3 or 4 core cable. Where a 3 core cable is utilised, with the shield operating as an earth conductor, the shield must have a cross sectional area at least equal to the phase conductors when they are made from the same material. Where a 4 core cable is utilised, the earth conductor must be of at least equal cross sectional area and manufactured from the same material as the phase conductors.
- For compliance with the European EMC directive, a suitable screened (shielded) cable should be used. Braided or twisted type screened cable where the screen covers at least 85% of the cable surface area, designed with low impedance to HF signals are recommended as a minimum. Installation within a suitable steel or copper tube is generally also acceptable
- Where drives are mounted in a steel control panel enclosure, the cable screen should be terminated directly to the control panel using a suitable EMC clamp or gland, as close to the drive as possible and as illustrated in section 6.1.

6.5.2. Motor Termination

- The motor earth must be connected to one of the Optidrive P2 Elevator drive earth terminals.
- The cable screen should be terminated at the motor end using an EMC type gland allowing connection to the motor body through the largest possible surface area.

6.5.3. Precautions

- The PWM output switching from any inverter when used with a long motor cable length can cause an increase in the voltage at the motor terminals, depending on the motor cable length and inductance. The rise time and peak voltage can affect the service life of the motor. Invertek Drives recommend using an output choke for motor cable lengths of 50m or more to ensure good motor service life.
- Connect the Optidrive P2 Elevator drive according to section 6.3, ensuring that motor terminal box connections are correct. There are two connections in general: Star and Delta. It is essential to ensure that the motor is connected in accordance with the voltage at which it will be operated. For more information, refer to section 6.5.4 Motor Terminal Box Connections.

6.5.4. Motor Terminal Box Connections

- Most general purpose motors are wound for operation on dual voltage supplies. This is indicated on the nameplate of the motor
- This operational voltage is normally selected when installing the motor by selecting either STAR or DELTA connection. STAR always gives the higher of the two voltage ratings.

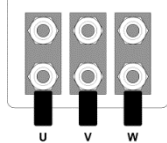
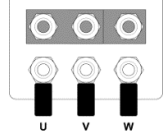
Incoming Supply Voltage	Motor Nameplate Voltages		Connection
230	230 / 400	Delta	
400	400 / 690		
400	230 / 400	Star	

6.6. Motor Thermal overload Protection.

6.6.1. Internal Thermal overload protection.

The drive has an in-built motor thermal overload function; this is in the form of an "I_{tr}" trip after delivering >100% of the value set in P1-08 for a sustained period of time (150% for 60 seconds).

6.6.2. Motor Thermistor Connection

Where a motor thermistor is to be used, it should be connected as follows:-

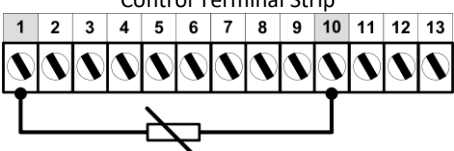
	<p>Additional Information</p> <ul style="list-style-type: none"> Compatible Thermistor : PTC Type, 2.5kΩ trip level Use a setting of P1-13 that has an input as External Trip, e.g. P1-13 = 2. Refer to section 6.10.1 for further details.
---	--

6.7. Control Terminal Wiring

1. All analog signal cables should be suitably shielded. Twisted pair cables are recommended.
2. Power and Control Signal cables should be routed separately where possible, and must not be routed parallel to each other
3. Signal levels of different voltages e.g. 24 Volt DC and 110 Volt AC, should not be routed in the same cable.
4. Maximum control terminal tightening torque is 0.5Nm

6.8. Control Terminals Connection Diagram

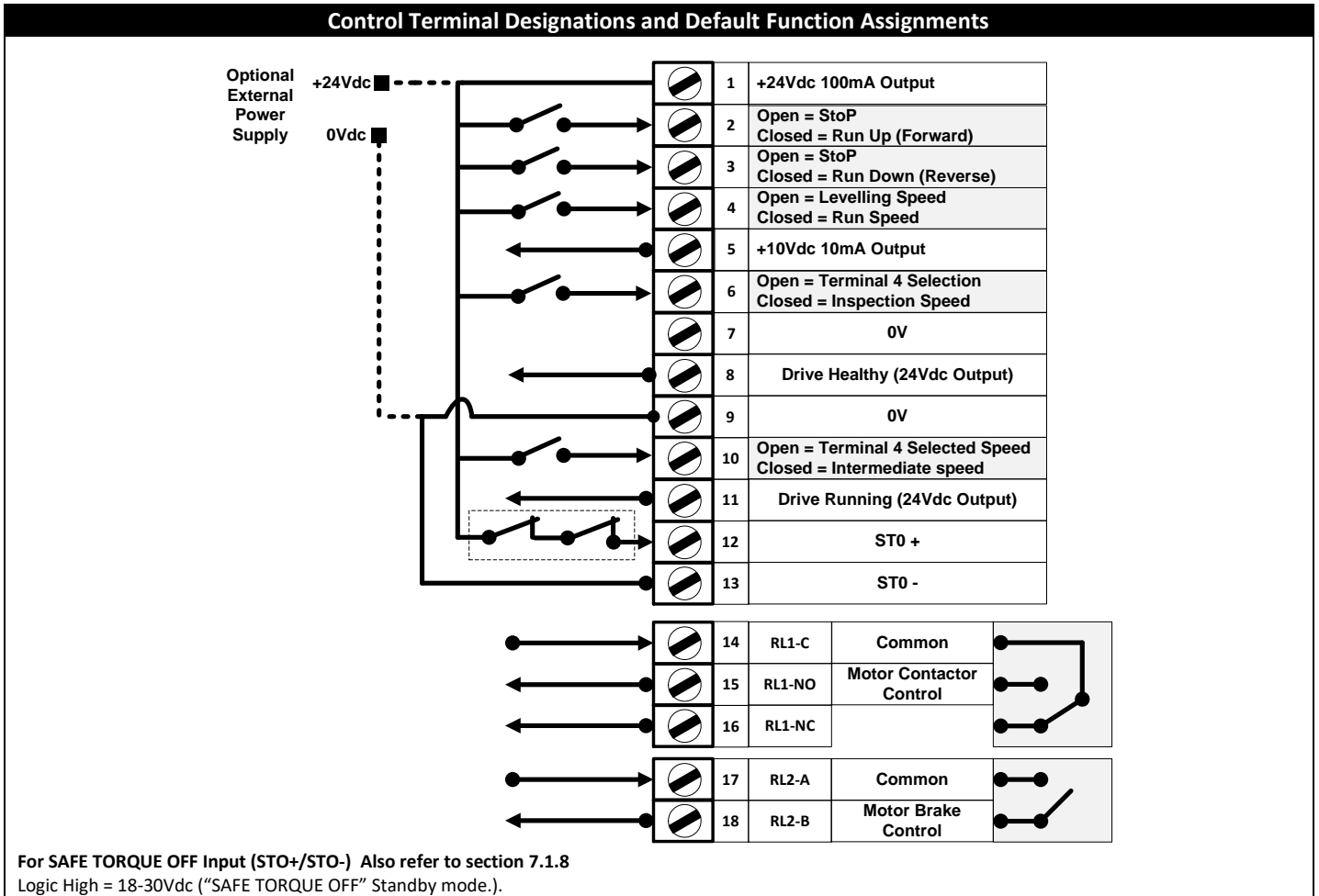

6.9. Control Terminal Connections

Main Terminal Strip			
1	+24V	+ 24V User Input / Output	100mA User Output
2	DI 1	Input 1	Digital 8 – 30 Volt DC
3	DI 2	Input 2	Digital 8 – 30 Volt DC
4	DI 3	Input 3	Digital 8 – 30 Volt DC
5	+10V	+ 10 Volt User Output	10mA for user potentiometer
6	DI 4	Input 4	Digital 8 to 30V DC
7	0V	0 Volt Common	
8	AO1	Output 1	1 st Analog / Digital Output, 0 to 10V, 4 to 20mA or +24VDC Digital
9	0V	0 Volt Common	
10	DI 5	Input 5	Digital 8 to 30V DC
11	AO2	Output 2	2 nd Analog / Digital Output, 0 to 10V, 4 to 20mA, Digital 24V
12	STO+	Drive hardware inhibit	"Safe torque Off" 24V input - must be linked to ext +24 Volt (18 – 30 Volt) DC to enable power stage
13	STO-	Inhibit 0V input	0V return for the 24V "Safe torque OFF" input (STO)
Additional Terminal Strip			
14	RL1-C	Relay Output 1 Common	Relay contacts, 250V AC, 30V DC, 5A
15	RL1-NO	Relay Output 1 NO	Relay contacts, 250V AC, 30V DC, 5A
16	RL1-NC	Relay Output 1 NC	Relay contacts, 250V AC, 30V DC, 5A
17	RL2-A	Relay Output 2 Common	Relay contacts, 250V AC, 30V DC, 5A
18	RL2-B	Relay Output 2 NO	Relay contacts, 250V AC, 30V DC, 5A

6.10. Control Terminal Configuration.

P1-13 defines the function of each of the control terminals and should be set to match the connected controller.

6.10.1. Digital Input Configuration Parameter (P1-13)

The below table assumes the drive already has a direction command given i.e. Terminal 2 or 3 input is high.

P1-13	Digital Input 3 (T4)	Digital Input 4 (T6)	Digital Input 5 (T10)	Active Speed
1 (Option 1) Default	1	0	0	P2-02 (High Speed)
	0 or 1	0	1	P2-03 (Intermediate Speed)
	0 or 1	1	0 or 1	P2-04 (Inspection Speed)
	0	0	0	P2-01 (Levelling Speed)
2 (Option 2)	1	0	*1	P2-02 (High Speed)
	0 or 1	1	*1	P2-04 (Inspection Speed)
	0	0	*1	P2-01 (Levelling Speed)
3 (Option 3)	1	0	0	P2-02 (High Speed)
	0 or 1	1	0	P2-04 (Inspection Speed)
	0	0	0	P2-01 (Levelling Speed)
4 (Option 4)	1	0	**1	P2-02 (High Speed)
	0 or 1	1	**1	P2-04 (Inspection Speed)
	0	0	**1	P2-01 (Levelling Speed)
5 (Option 5)	Brake release monitoring function see section 14.4 for details			
6 (Option 6) (Multispeed Selection)	0	0	0	P2-01
	1	0	0	P2-02
	0	1	0	P2-03
	1	1	0	P2-04
	0	0	1	P2-05 (For rescue mode only) (Max 5.0Hz)
	1	0	1	P2-06
	0	1	1	P2-07
	1	1	1	P1-01
7 (Option 7)	1	0	0/1 (1 = Rescue mode enable)	P2-02 (High Speed)/ P2-05 (rescue speed)
	0 or 1	1	0/1 (1 = Rescue mode enable)	P2-04 (Inspection Speed)/ P2-05 (rescue speed)
	0	0	0/1 (1 = Rescue mode enable)	P2-01 (Levelling Speed)/ P2-05 (rescue speed)

1= Input High 0 = Input Low

* If 0 the drive will trip on "E-Err IP" or F-Ptc if a motor thermistor fitted and Ptc-th has been selected in P2-33.

** If 0 drive will fast stop using deceleration ramp in time set in P2-25., if P2-25 is zero the drive will coast to stop.

6.11. Motor Contactor Control

Related Parameters	Action
P3-06 (OUTPUT CONTACTOR CLOSING TIME/RUN COMMAND DELAY TIME)	1 Ensure advanced parameter access is enabled by setting P1-14 = 101
	2 If Motor contactor activation is to come from the drive set P2-15 to 8.(Relay 1 output function select)
	3 Program parameter P3-06 as per the profile diagram below.
STO Input (T12+ T13)	<input type="checkbox"/>
Enable & Direction Input (T2 or T3)	<input type="checkbox"/>
Run Speed Input (T4)	<input type="checkbox"/>
Motor Contactor Close (Relay 1)	<input type="checkbox"/>
Zero speed Holding (IM motor only)	<input type="checkbox"/>
Drive Output Enabled	<input type="checkbox"/>
P3-06 (OUTPUT CONTACTOR CLOSING TIME/RUN COMMAND DELAY TIME)	If Elevator controller is being used for motor contactor activation Sets a delay time between the enable signal being applied to the drive and the drive energising the motor. This ensures that an output contactor between the drive and motor has had enough time to close before the drive output comes on. A value too low in this parameter may cause over current trips/Excess wear on the Contactor/Motor. Note : When the drive is started it will remain in a "StoP" state until the value in P3-06 has elapsed, however if the start command signal is toggled in the time less than P3-06 then the drive will not carry out the delay time and the drive output will come on immediately.
	If drive is being used for motor contactor activation (P2-15=8) via Relay 1 Use P3-06 to set the delay time required for the relay contacts to close/open. When the Enable (Run) signal is applied to the drive, the drive will signal the contactor to close, and then wait for the delay time set in P3-06 before applying torque to the motor. When the Enable (Run) signal is removed from the drive, the drive will signal the contactor to open after the time set in P3-06 has elapsed.

6.12. Motor Holding Brake Control

The Optidrive P2 Elevator drive has been designed to control the holding brake on motors where a separate electromechanical brake is fitted. The brake is controlled by the output relay (terminals 17 and 18) – see section 6.8 for details.

There are two different options for controlling the closing operation of the brake during stopping.

6.12.1. Motor Holding Brake control-Option 1

Closing the brake at a parameter adjustable output frequency level. This allows the brake to be signalled to close whilst the drive is decelerating, allowing the user to preset the frequency so that the brake closes simultaneously when the output frequency reaches zero.

Related Parameters		Action																																																																																																																																																								
P3-07 (Brake Release Time) P3-09 (Brake Apply Speed) P3-10 (Zero Speed Holding Time on disable)		Program parameters as per the profile diagram below. 																																																																																																																																																								
		<table border="1"> <tr> <td>STO Input</td> <td></td><td></td><td></td><td></td><td></td><td></td><td></td><td></td><td></td><td></td><td></td><td></td><td></td><td></td><td></td><td></td><td></td><td></td> </tr> <tr> <td>Enable & Direction Input</td> <td></td><td></td><td></td><td></td><td></td><td></td><td></td><td></td><td></td><td></td><td></td><td></td><td></td><td></td><td></td><td></td><td></td><td></td> </tr> <tr> <td>Run Speed Input</td> <td></td><td></td><td></td><td></td><td></td><td></td><td></td><td></td><td></td><td></td><td></td><td></td><td></td><td></td><td></td><td></td><td></td><td></td> </tr> <tr> <td>Drive Output Enabled</td> <td></td><td></td><td></td><td></td><td></td><td></td><td></td><td></td><td></td><td></td><td></td><td></td><td></td><td></td><td></td><td></td><td></td><td></td> </tr> <tr> <td>Output Frequency >0</td> <td></td><td></td><td></td><td></td><td></td><td></td><td></td><td></td><td></td><td></td><td></td><td></td><td></td><td></td><td></td><td></td><td></td><td></td> </tr> <tr> <td>Motor Contactor Output</td> <td></td><td></td><td></td><td></td><td></td><td></td><td></td><td></td><td></td><td></td><td></td><td></td><td></td><td></td><td></td><td></td><td></td><td></td> </tr> <tr> <td>Brake Control Output</td> <td></td><td></td><td></td><td></td><td></td><td></td><td></td><td></td><td></td><td></td><td></td><td></td><td></td><td></td><td></td><td></td><td></td><td></td> </tr> <tr> <td>Drive Enabled Output</td> <td></td><td></td><td></td><td></td><td></td><td></td><td></td><td></td><td></td><td></td><td></td><td></td><td></td><td></td><td></td><td></td><td></td><td></td> </tr> </table>	STO Input																			Enable & Direction Input																			Run Speed Input																			Drive Output Enabled																			Output Frequency >0																			Motor Contactor Output																			Brake Control Output																			Drive Enabled Output																		
STO Input																																																																																																																																																										
Enable & Direction Input																																																																																																																																																										
Run Speed Input																																																																																																																																																										
Drive Output Enabled																																																																																																																																																										
Output Frequency >0																																																																																																																																																										
Motor Contactor Output																																																																																																																																																										
Brake Control Output																																																																																																																																																										
Drive Enabled Output																																																																																																																																																										
A	STO Input Closed by external control system Run Forward / Run Reverse input applied by External Control System Run Speed (High Speed) Input Closed by External Control System Motor Contactor Output (Relay 1) set by drive (to close motor contactor) Drive waits for Output Contactor Closing time (P3-06) before enabling the output stage to drive the motor																																																																																																																																																									
B	After the Motor Contactor Delay time (P3-06) has elapsed, the Drive Output to the motor is enabled at zero speed Drive holds zero speed on the output, and magnetises the motor (IM Motor) For PM Motor, the magnetizing time is zero																																																																																																																																																									
C	After the Motor Magnetizing Time has elapsed, the motor brake control output (Relay 2) is set to release the motor brake The output Frequency remains at zero until the Motor Brake Release Time (P3-07) has elapsed																																																																																																																																																									
D	After the Motor Brake Release Time (P3-07) has elapsed, the drive output frequency is ramped up. The Ramp Rate is controlled initially using Acceleration S-Ramp 1 (P3-01)																																																																																																																																																									
E	The Acceleration rate is now controlled linearly by the Acceleration Ramp Parameter (P1-03)																																																																																																																																																									
F	As the Run Speed is approached, the acceleration is now controlled by Acceleration S-Ramp 2 (P3-02)																																																																																																																																																									
G	Operation at Run Speed (P2-02)																																																																																																																																																									
H	When the Run Speed Input is removed, the drive output frequency is reduced to the Levelling Speed (P2-01). Deceleration is initially controlled by Deceleration S-Ramp 1 (P3-03)																																																																																																																																																									
I	After Deceleration S-Ramp 1 (P3-03) has completed, deceleration is controlled linearly by the Deceleration Ramp Parameter (P1-04)																																																																																																																																																									
J	As the output frequency approaches the Levelling Speed (P2-01), Deceleration S-Ramp 2 (P3-04) is applied																																																																																																																																																									
K	The drive operates at the Levelling Speed (P2-01) until the Direction Input is removed																																																																																																																																																									
L	On removal of the Direction input, the output frequency is reduced towards zero, with deceleration rate initially controlled by Levelling S-Ramp (P3-05)																																																																																																																																																									
M	If the deceleration time is long enough to require linear deceleration, Deceleration Ramp Time (P1-04) is used As the output frequency approaches zero, Levelling S-Ramp (P3-05) is again applied																																																																																																																																																									
N	When the output frequency reaches the Brake Apply Speed (P3-09), the motor brake control signal is removed to allow the motor brake to close. Output frequency continues to ramp towards zero speed, holding at zero speed.																																																																																																																																																									
O	After the Zero Speed Holding Time (P3-10) has elapsed, the drive output is disabled For IM Motor control, a demagnetisation time is allowed for the motor prior to removing the Motor Contactor Output signal, allowing the contactor to open. (This is not required for PM motors)																																																																																																																																																									
P	The Motor Contactor signal is removed allowing the contactor to open																																																																																																																																																									
Q	The STO Input to the drive can now be opened by the control system																																																																																																																																																									

6.12.2. Motor Holding Brake Control-Option 2

If the brake Apply Speed (P3-09) parameter is set to zero (default setting), an additional parameter (P3-08) is used to define the time that the drive should wait whilst holding the motor at zero speed prior to signalling the brake to close.

Related Parameters		Action
P3-07(Brake Release Time) P3-08(Brake Apply Delay) P3-10(Zero Speed Holding Time on disable)		Program parameters as per the profile diagram below.
STO Input		
Enable & Direction Input		
Run Speed Input		
Drive Output Enabled		
Output Frequency >0		
Motor Contactor Output		
Brake Control Output		
Drive Enabled Output		
A	STO Input Closed by external control system Run Forward / Run Reverse input applied by External Control System Run Speed (High Speed) Input Closed by External Control System Motor Contactor Output (Relay 1) set by drive (to close motor contactor) Drive waits for Output Contactor Closing Time (P3-06) before enabling the output stage to drive the motor	
B	After the Motor Contactor Delay (P3-06) time has elapsed, the Drive Output to the motor is enabled at zero speed Drive holds zero speed on the output, and magnetises the motor (IM Motor) For PM Motor, the magnetizing time is zero	
C	After the Motor Magnetizing Time has elapsed, the motor brake control output (Relay 2) is set to release the motor brake The output Frequency remains at zero until the Motor Brake Release Time (P3-07) has elapsed	
D	After the Motor Brake Release Time (P3-07) has elapsed, the drive output frequency is ramped up. The Ramp Rate is controlled initially using Acceleration S-Ramp 1 (P3-01)	
E	The Acceleration rate is now controlled linearly by the Acceleration Ramp Parameter (P1-03)	
F	As the Run Speed is approached, the acceleration is now controlled by Acceleration S-Ramp 2 (P3-02)	
G	Operation at Run Speed (P2-02)	
H	When the Run Speed Input is removed, the drive output frequency is reduced to the Levelling Speed (P2-01). Deceleration is initially controlled by Deceleration S-Ramp 1 (P3-03)	
I	After Deceleration S-Ramp 1 (P3-03) has completed, deceleration is controlled linearly by the Deceleration Ramp Parameter (P1-04)	
J	As the output frequency approaches the Levelling Speed (P2-01), Deceleration S-Ramp 2 (P3-04) is applied	
K	The drive operates at the Levelling Speed (P2-01) until the Direction Input is removed	
L	On removal of the Direction input, the output frequency is reduced towards zero, with deceleration rate initially controlled by Levelling S-Ramp (P3-05)	
M	If the deceleration time is long enough to require linear deceleration, Deceleration Ramp Time (P1-04) is used As the output frequency approaches zero, Levelling S-Ramp (P3-05) is again applied	
N	The Output frequency reaches zero. The drive holds at zero frequency and waits until the Motor Brake Apply Delay Time (P3-08) has elapsed	
O	When the Motor Brake Apply Delay (P3-08) has elapsed, the Holding brake control relay opens (relay 2), so that the motor brake applies. The drive output remains enabled at zero frequency for the Zero Speed Holding Time (P3-10)	
P	When the Zero Speed Holding Time (P3-10) has elapsed, the drive output is disabled The Motor Output Contactor signal remains on for the time period set in the Motor Contactor Delay Parameter (P3-06)	
Q	After the Motor Contactor Delay Time (P3-06) has elapsed, the motor contactor output switches off allowing the motor contactor to open	
R	The STO Input to the drive can now be opened by the control system	

7. Safe Torque Off

7.1. Safe Torque Off

Safe Torque OFF will be referred to as “STO” through the remainder of this section.

7.1.1. Responsibilities

The overall system designer is responsible for defining the requirements of the overall “Safety Control System” within which the drive will be incorporated; furthermore the system designer is responsible for ensuring that the complete system is risk assessed and that the “Safety control System” requirements have been entirely met and that the function is fully verified, this must include confirmation testing of the “STO” function before drive commissioning.

The system designer shall determine the possible risks and hazards within the system by carrying out a thorough risk and hazard analysis, the outcome of the analysis should provide an estimate of the possible hazards, furthermore determine the risk levels and identify any needs for risk reduction. The “STO” function should be evaluated to ensure it can sufficiently meet the risk level required.

7.1.2. What STO Provides

The purpose of the “STO” function is to provide a method of preventing the drive from creating torque in the motor in the absence of the “STO” input signals (Terminal 12 with respect to Terminal 13), this allows the drive to be incorporated into a complete safety control system where “STO” requirements need to be fulfilled.¹

The “STO” function can typically eliminate the need for electro-mechanical contactors with cross-checking auxiliary contacts as per normally required to provide safety functions.²

The drive has the “STO” function built-in as standard and complies with the definition of “Safe torque off” as defined by IEC 61800-5-2:2007.

The “STO” function also corresponds to an uncontrolled stop in accordance with category 0 (Emergency Off), of IEC 60204-1. This means that the motor will coast to a stop when the “STO” function is activated, this method of stopping should be confirmed as being acceptable to the system the motor is driving.

The “STO” function is recognised as a fail-safe method even in the case where the “STO” signal is absent and a single fault within the drive has occurred, the drive has been proven in respect of this by meeting the following safety standards :

	SIL (Safety Integrity Level)	PFH _D (Probability of dangerous Failures per Hour)	SFF (Safe failure fraction %)	Lifetime assumed
EN 61800-5-2	2	1.23E-09 1/h (0.12 % of SIL 2)	50	20 Yrs.

	PL (Performance level)	CCF (%) (Common Cause Failure)
EN ISO 13849-1	PL d	1

	SILCL
EN 62061	SILCL 2

Note : The values achieved above maybe jeopardised if the drive is installed outside of the Environmental limits detailed in section 18.1 “Environmental”.

7.1.3. What STO does not provide



Disconnect and ISOLATE the drive before attempting any work on it. The “STO” function does not prevent high voltages from being present at the drive power terminals.



¹ Note: The “STO” function does not prevent the drive from an unexpected re-start. As soon as the “STO” inputs receive the relevant signal it is possible (subject to parameter settings) to restart automatically, Based on this, the function should not be used for carrying out short-term non-electrical machinery operations (such as cleaning or maintenance work).



² Note: In some applications additional measures may be required to fulfil the systems safety function needs: the “STO” function does not provide motor braking. In the case where motor braking is required a time delay safety relay and/or a mechanical brake arrangement or similar method should be adopted, consideration should be made over the required safety function when braking as the drive braking circuit alone cannot be relied upon as a fail-safe method.



When using Gearless (Permanent Magnet) motors and in the unlikely event of a multiple output power devices failing then the motor could effectively rotate the motor shaft by 180/p degrees (Where p denotes number of motor pole pairs).

7.1.4. "STO" Operation

When the "STO" inputs are energised, the "STO" function is in a standby state, if the drive is then given a "Start signal/command" (as per the start source method selected in P1-13) then the drive will start and operate normally.

When the "STO" inputs are de-energised then the STO Function is activated and stops the drive (Motor will coast), the drive is now in "Safe Torque Off" mode.

To get the drive out of "Safe Torque Off" mode then any "Fault messages" need to be reset and the drive "STO" input needs to be re-energised.

7.1.5. "STO" Status and Monitoring

There are a number of methods for monitoring the status of the "STO" input, these are detailed below:

Drive Display

In Normal drive operation (Mains AC power applied), when the drives "STO" input is de-energised ("STO" Function activated) the drive will highlight this by displaying "InHibit", (Note: If the drive is in a tripped condition then the relevant trip will be displayed and not "InHibit").

Drive Output Relay

- Drive relay 1: Setting P2-15 to a value of "13" will result in relay opening when the "STO" function is activated.
- Drive relay 2: Setting P2-18 to a value of "13" will result in relay opening when the "STO" function is activated.

"STO" Fault Codes

Fault Code	Code Number	Description	Corrective Action
"Sto-F"	29	A fault has been detected within either of the internal channels of the "STO" circuit.	Refer to your Invertek Sales Partner

7.1.6. "STO" Function response time

The total response time is the time from a safety related event occurring to the components (sum of) within the system responding and becoming safe. (Stop Category 0 in accordance with IEC 60204-1)

1. The response time from the "STO" inputs being de-energised to the output of the drive being in a state that will not produce torque in the motor ("STO" active) is less than 1ms.
2. The response time from the "STO" inputs being de-energised to the "STO" monitoring status changing state is less than 20ms
3. The response time from the drive sensing a fault in the STO circuit to the drive displaying the fault on the display/Digital output showing drive not healthy is less than 20ms.
- 4.

7.1.7. "STO" Electrical Installation



The "STO" wiring shall be protected from inadvertent short circuits or tampering which could lead to failure of the "STO" input signal, further guidance is given in the diagrams below.

In addition to the wiring guidelines for the "STO" circuit below, section 6.1 "Installation in accordance with Good EMC Practice" should also be followed.

The drive should be wired as illustrated below; the 24Vdc signal source applied to the "STO" input can be either from the 24Vdc on the drive or from an External 24Vdc power supply.

7.1.8. Recommended "STO" wiring

Using an External 24Vdc Power Supply.

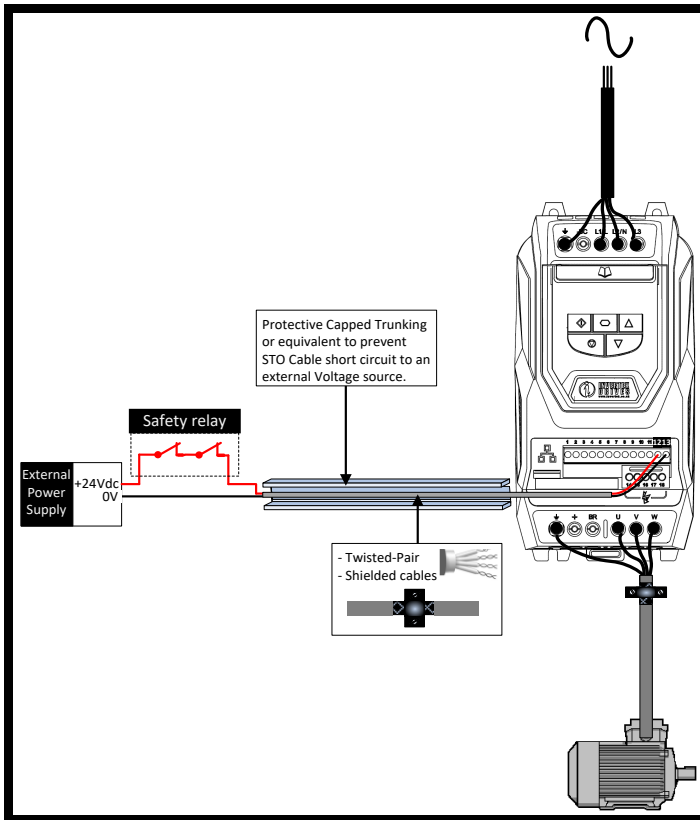

Using the drives on-board 24Vdc supply

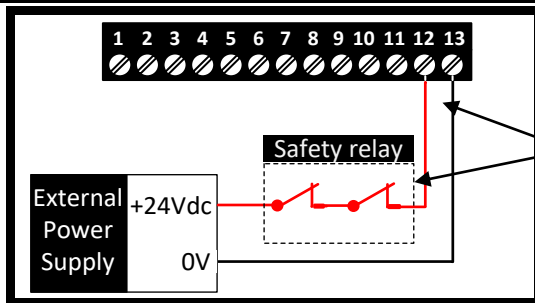
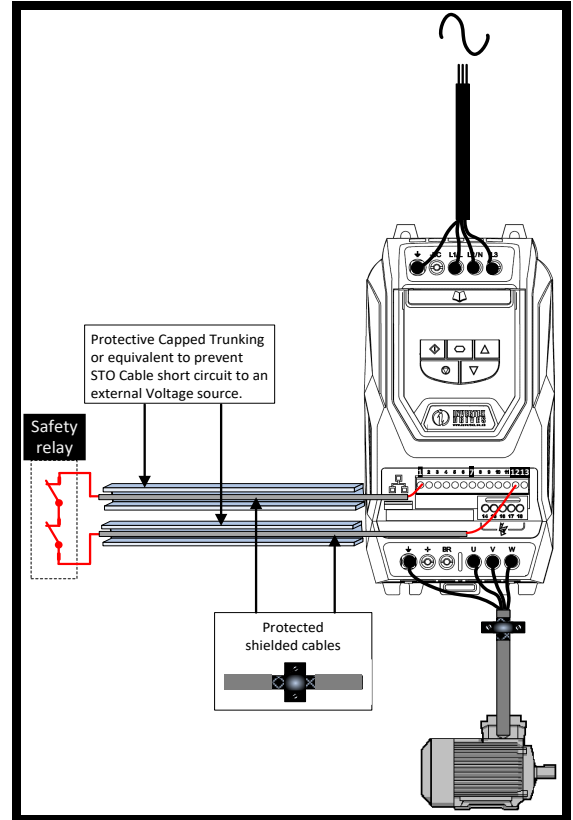

Wires should be protected against short circuits as shown above

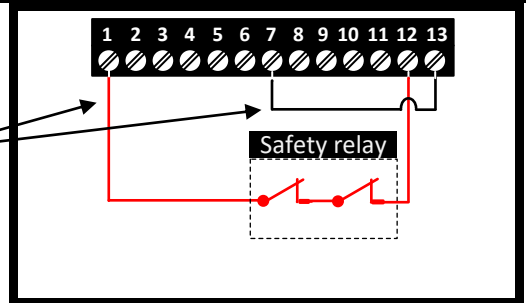

Note: The Maximum cable length from Voltage source to the drive terminals should not exceed 25 metres.

7.1.9. External Power supply Specification.

Voltage Rating (Nominal)	24Vdc
STO Logic High	18-30Vdc (Safe torque off in standby)
Current Consumption (Maximum)	100mA

7.1.10. Safety Relay Specification.

The safety relay should be chosen so that at minimum it meets the safety standards in which the drive meets.

Standard Requirements	SIL2 or PLd SC3 or better (With Forcibly guided Contacts)
Number of Output Contacts	2 independent
Switching Voltage Rating	30Vdc
Switching Current	100mA

7.1.11. Enabling the “STO” Function

The “STO” function is always enabled in the drive regardless of operating mode or parameter changes made by the user.

7.1.12. Testing the “STO” Function

Before commissioning the system the “STO” function should always be tested for correct operation, this should include the following tests:

- With the motor at standstill, and a stop command given to the drive (*as per the start source method selected in P1-13*):
 - De-energise the “STO” inputs (Drive will display “InHibit”).
 - Give a start command (*as per the start source method selected in P1-13*) and check that the drive still displays “Inhibit” and that the operation is in line with section 7.1.4 and section 7.1.5 “STO” Status and Monitoring
- With the motor running normally (from the drive):
 - De-energise the “STO” inputs
 - Check that the drive displays “InHibit” and that the motor stops *and* that the operation is in line with the section 7.1.4 “STO” Operation *and* section 7.1.5 “STO” Status and Monitoring.

7.1.13. “STO” Function Maintenance.

The “STO” function should be included within the control systems scheduled maintenance program so that the function is regularly tested for integrity (Minimum once per Year), furthermore the function should be integrity tested following any safety system modifications or maintenance work.

If drive fault messages are observed refer to section 19.1 Fault messages for further guidance.

8. Optional Encoder Interface modules

There are 4 types of encoder interface modules which allow the Optidrive P2 Elevator drive to interface with the following encoder types.

- 5V TTL Incremental Encoder – A & B Channel with Compliment
- 24V HTL Incremental Encoder – A & B Channel with Compliment
- Endat Absolute Rotary Encoder (Heidenhain) – ECN1313, ECN113, ECN413, ECN1325, ECN125, ECN425.
- SinCos Rotary Encoder (Heidenhain) – ERN 1387

8.1. Encoder interface module Mechanical Installation

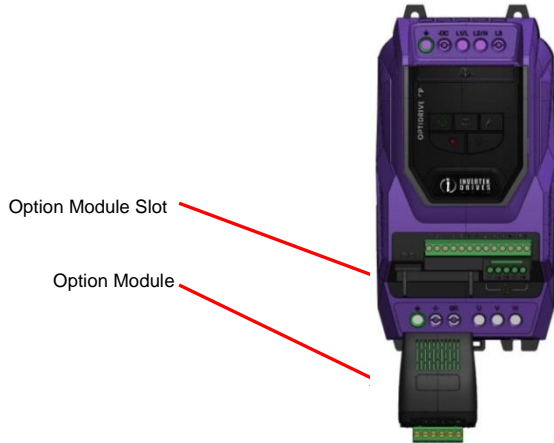

8.2. Encoder interface module electrical installation

OPT-2-ENCOD-IN
Connection Example – 5V TTL Encoder



OPT-2-ENCHT-IN
Connection Example – 24V HTL Encoder

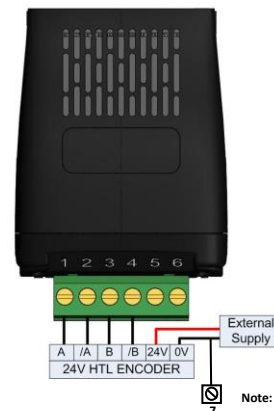

Alternatively (to External supply) the drives on-board 24V supply can be used (T1 (24V) and T7 (0V)) – Ensure total current consumption from T1 does not exceed 100mA.

OPT-2-ENDAT2-IN
Endat Absolute Encoder Connections
OPT-2-SINCOS2-IN
SinCos Encoder Connections

Terminal	Endat Connection	SinCos Connection
1	+5V Supply to Encoder	
2	0V	
3	DATA	C+
4	DATA/	C-
5	CLOCK	D+
6	CLOCK/	D-
7	A+	A+
8	A-	A-
9	B+	B+
10	B-	B-
11	Shield/Screen	



Terminal	Simulated Encoder Output
12	0V
13	A_P (Out)
14	A_N (Out)
15	B_P (Out)
16	B_N (Out)
17	Shield/Screen
Brake release monitoring	
18	Brake 1
19	Brake 2

- The encoder cable should be screened, ideally with each signal pair individually screened. The screen should be connected to the 0V of the encoder module, or shield/screen connection (OPT-2-ENDAT2-IN/OPT-2-SINCOS2-IN).
- The resolution of the simulated encoder output is as per the connected encoder.

Note: Simulated Encoder output only possible if incremental signals 7 thru to 10 are connected.





8.3. Encoder interface module parameter setup

See section 11.6 (Incremental) and 12.6 (Endat/SinCos) for parameterisation and commissioning.



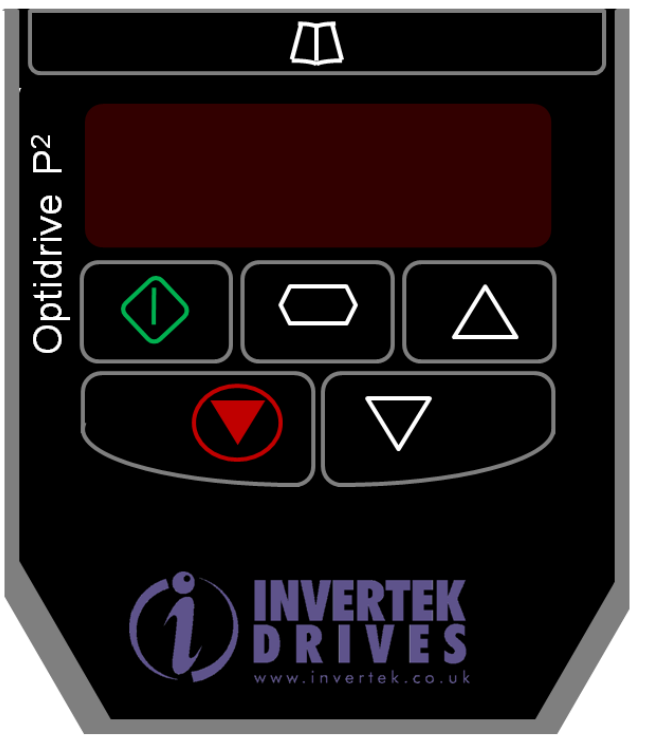





9. Managing the Keypad

The drive is configured and its operation monitored via the keypad and display.

9.1. Keypad Layout and Function – Standard LED Keypad

	NAVIGATE	Used to display real-time information, to access and exit parameter edit mode and to store parameter changes	
	UP	Used to increase speed in real-time mode or to increase parameter values in parameter edit mode	
	DOWN	Used to decrease speed in real-time mode or to decrease parameter values in parameter edit mode	
	RESET / STOP	Used to reset a tripped drive. When in Keypad mode is used to Stop a running drive.	
	START	When in keypad mode, used to Start a stopped drive or to reverse the direction of rotation if bi-directional keypad mode is enabled	

9.2. Changing Parameters

Procedure	Display shows...
Power on Drive	StoP
Press and hold the  for >2 seconds	P 1-01
Press the  Key	P 1-02
The  and  can be used to select the desired parameter	P 1-03 etc..
Select the required parameter, e.g. P1-02	P 1-02
Press the  button	0.0
Use  the  and keys to adjust the value, e.g. set to 10	10.0
Press the  key	P 1-02
The parameter value is now adjusted and automatically stored. Press the  key for >2 seconds to return to operating mode	StoP

9.3. Advanced Keypad Operation Short Cuts



Function	When Display shows...	Press...	Result	Example
Fast Selection of Parameter Groups Note : Parameter Group Access must be enabled P1-14 = 101	P _{x-xx}		The next highest Parameter group is selected	Display shows P 1-10 Press Display shows P2-01
	P _{x-xx}		The next lowest Parameter group is selected	Display shows P2-26 Press Display shows P 1-01
Select lowest Group Parameter	P _{x-xx}		The first parameter of a group is selected	Display shows P 1-10 Press Display shows P 1-01
Set Parameter to minimum value	Any numerical value (Whilst editing a parameter value)		The parameter is set to the minimum value	When editing P1-01 Display shows 50.0 Press Display shows 0.0
Adjusting individual digits within a parameter value	Any numerical value (Whilst editing a parameter value)		Individual parameter digits can be adjusted	When editing P1-10 Display shows 0 Press Display shows -0 Press Display shows 10 Press Display shows -10 Press Display shows 110 Etc...

9.4. Drive Operating Displays

Display	Status	
StoP	Drive mains power applied, but no Enable or Run signal applied	
Autot	Motor Autotune in progress.	
H x.x	Drive running, display shows output frequency (Hz)	Whilst the drive is running, the following displays can be selected by briefly pressing the button on the drive. Each press of the button will cycle the display through to the next selection.
A x.x	Drive running, display shows motor current (Amps)	
P x.x	Drive Running, display shows motor power (kW)	
[x.x	Drive Running, display shows customer selected units, see parameters P2-21 and P2-22	
UP dn	When in rescue mode (With encoder) the direction of travel can be displayed, it is assumed that when a run up (forward) command (e.g. terminal 2 closed) is given the motor rotates clockwise (looking at the motor with the sheave facing you).	
E _L -24	Drive mains power not present, external 24 Volt control power supply present only	
Inhibt	Output power hardware inhibited, Safe Torque Off function activated. External links are required to the STO inputs (terminals 12 and 13) as shown in section 6.8 Control Terminals Connection Diagram	
P-dEF	Parameters reset to factory default settings	
U-dEF	Parameters reset to User default settings (P6-29=1)	

For drive fault code displays, refer to section 19.1

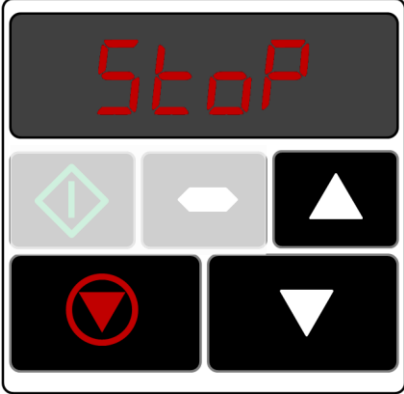
9.5. Resetting Parameters to Factory Default Settings

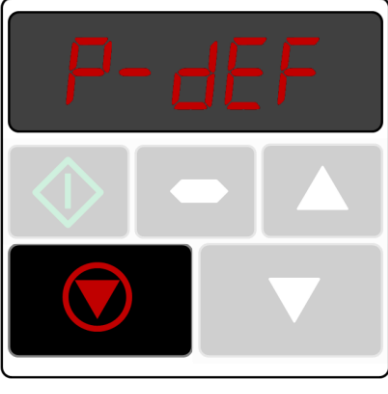
LED Display		
	<p>Press and hold the  Keys for at least 2 seconds The display will show P-dEF Press the  key</p>	

9.6. Resetting Parameters to User Default Settings

The current parameter settings of the drive can be stored internally within the drive as the standard default settings. This does not affect the procedure for returning the drive to factory default settings as described above.

P6-29 (Save user parameters as default) can be enabled (set to 1) to invoke a parameter save of the current parameter values as the standard defaults for the drive. Parameter menu group 6 can only be accessed with advanced security level access (Default P1-14=201).

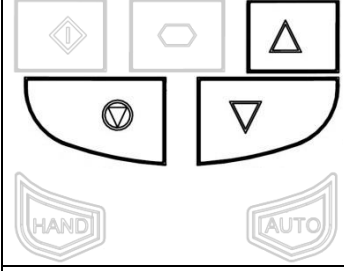
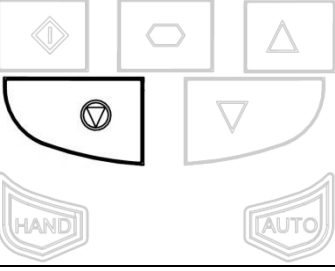
STOP	Load default parameters U-DEF
37kW 400V 3Ph	Press STOP key to Reset
	
Hold down the Up, Down, Start and Stop keys for >2s	The display shows P-Def. Drive is returned to factory settings. Press the Stop key

Note: Parameters cannot be defaulted whilst P2-39=1 (parameter set locked).

9.7. Elevator Specific Linear Units

The drive provides the user with the option to program the drive and view the elevator speed in real time in elevator units e.g. m/s, the drive calculates the value internally providing the correct values are entered into the below parameters.

To enable this feature the user must program the following parameters:

- Motor Rated Speed (P1-10)
- Sheave Diameter (P3-15) (<100 drive assumes inches)/(>100 drive assumes mm)
- Roping Ratio (P3-16)
- Gear Ratio for Geared (Induction) systems (P3-17)

Note: If P1-10 and P3-15 are zero then the function is inactive.

Once the above parameters are programmed the user can view the real time travel speed by pressing the  (navigate button) until "r" is shown in the left side of the display, this is further detailed in section 9.1.

10.Start up and Commissioning

This chapter details the setup procedure of the drive, each section should be followed in accordance with the given instructions in order to achieve the required performance of the Elevator.

Commissioning flow diagram.

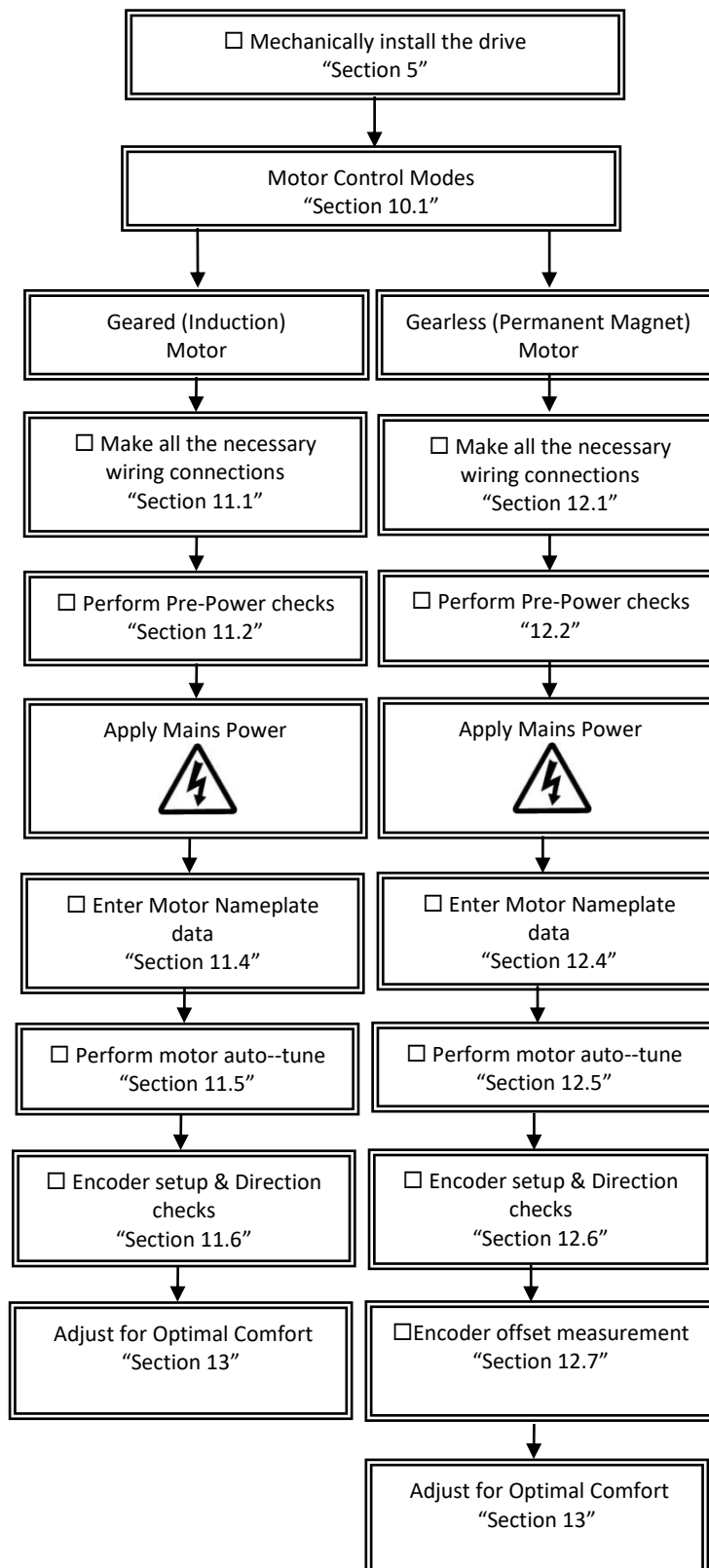

10.1. Motor Operating Modes.

In order to support a wide range of elevator motor types and vintages the Optidrive P2 Elevator drive has 4 different operating modes, the various operating modes are selected in parameter **P4-01** and are detailed in the table below.

P4-01	Operating Mode	Application
0	Advanced Vector IM Speed Control (With or Without Incremental Encoder feedback)	<ul style="list-style-type: none"> Recommended operating mode for Induction motors. Induction (geared) Motors where all motor data is available from the motor rating plate/ datasheet (Motor rated Voltage/Current/Frequency/Rated rpm/Power factor). Excellent low speed torque performance.
1	Vector IM Speed Control (With or Without Incremental Encoder feedback)	<ul style="list-style-type: none"> Alternative to setting 0 for Geared (Induction) Motors where the power factor value is not available from the motor rating plate/ datasheet. Low speed torque performance reduced compared to setting 0.
2	Enhanced V/F IM Speed Control	<ul style="list-style-type: none"> For Geared (Induction) Motors where settings 0 or 1 are not suitable for the connected motor .e.g. older motors or where vector control (settings 0 or 1) results in motor vibrations which cannot be tuned out by adjustment of the speed loop gains. In this mode the speed loop gains are not active. Low speed torque performance reduced compared to setting 0 and 1.
3	PM Motor Speed Control (With or *Without Absolute Encoder feedback)	<ul style="list-style-type: none"> Permanent magnet (gearless) Motors. Excellent low speed torque performance and efficiency.

*PM Open Loop Vector control with Limitations (Motor dependant), contact Invertek Technical/product support for further information

11. First Start-up of Geared (Induction) Motors.

The below procedure illustrates a method for commissioning the OPTIDRIVE P2 ELEVATOR drive in a typical elevator application, it is assumed the drive has already been mechanically installed.

11.1. Step 1- Wiring Connections.

The below diagram provides guidance for the wiring connections.

More technical information on the electrical wiring is available in section 6 and section 18 "Technical Data".



Before making any wiring connections ensure that all voltage/power sources are isolated.

11.1.1. Step 1- Wiring Connection diagram.

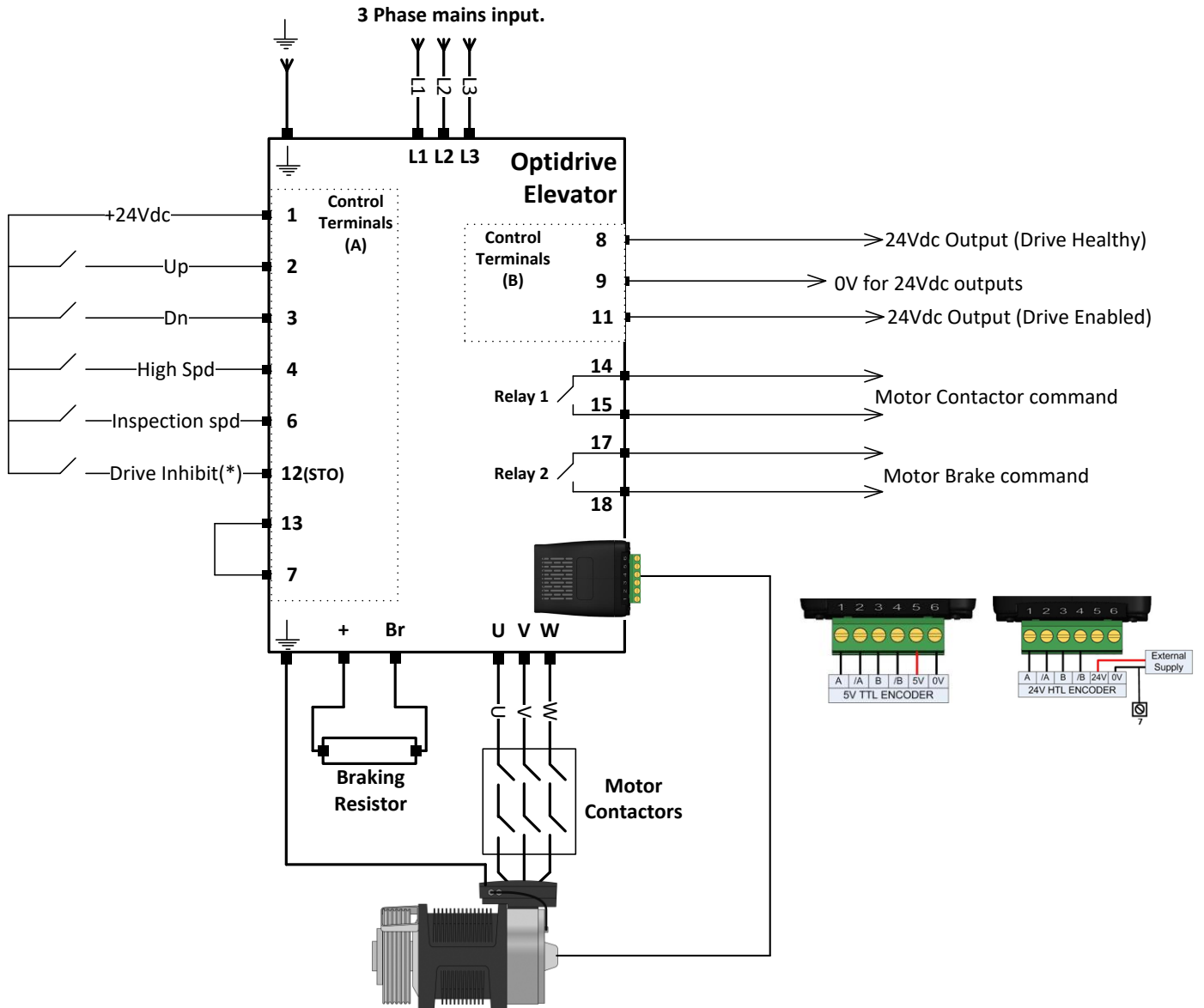

Cable screening/Shield	For Guidance on cable screening/shielding see section 6.1 "Installation in accordance with Good EMC Practice"	
Drive Inhibit (*)	From a fast relay connected downstream of the safety chain.	
Control Terminals (A)	Default configuration shown, for other configurations see section 6.10.1"	
Control Terminals (B)	Default status sources shown for digital outputs (terminal 8 and 11), for other status sources see parameters P2-11 (terminal 8 function) and P2-13	
Encoder Module	For 5V TTL Encoder use OPT-2-ENCOD-IN encoder module.	
	For 12-24V HTL Encoder use OPT-2-ENCHT-IN encoder module.	
	If Encoder does not have complimentary signals then connect as shown opposite >.	
Braking Resistor	Ensure braking resistor resistance is higher than minimum allowable value for the given drive rating, see section 18.3.	

11.2. Step 2- Pre-Power Checks.

	Action/Checks	Additional Information
 <p>Do Not Apply Electrical Power Yet!</p>	<ul style="list-style-type: none"> <input type="checkbox"/> Check that all safety circuits/safety chains are in the correct state, failure to do so could result in damage to the equipment and possible injury or death. <input type="checkbox"/> Check that the intended voltage source matches that of the drive voltage rating. <input type="checkbox"/> Check that any unexpected movement in the motor will not result in damage to equipment / safety risk to persons. <input type="checkbox"/> Check that the elevator controller will not give a start signal to the drive when Electrical power is applied. <input type="checkbox"/> Ideally the Lift car should be balanced (i.e. with brakes off the lift car should not naturally move) and with enough shaft headroom in order to prevent reaching end stops during initial test travels. 	
<p>Check all necessary electrical connections.</p>		<ul style="list-style-type: none"> <input type="checkbox"/> Check Electrical Supply cables are connected to the Input power terminals of the drive. <input type="checkbox"/> Check Motor Cables are connected to the drive U, V, W terminals (If cables have identification markers connect correct phase sequence). <input type="checkbox"/> Check Brake resistor is connected to the "+DC" and "BR" terminals of the drive. <input type="checkbox"/> Check correct control connections are made between the Elevator control panel and the drive. (as detailed in Section 11.1.1 "Step 1- Wiring Connection diagram.") <input type="checkbox"/> Check correct encoder module (optional) has been installed and the correct connections are made between the drive and the Encoder.

11.3. Step 3- Apply Power.



 Apply Electrical Power to the drive	<input type="checkbox"/> Apply rated voltage to the drive. <input type="checkbox"/> Check that the drive displays StoP or Inhibit . <input type="checkbox"/> Check that the Encoder module (Optional) left hand LED light is illuminated Green	<ul style="list-style-type: none"> ➤ If StoP or Inhibit is not shown refer to the troubleshooting section at the back of the user manual. ➤ If there is no green light shown on the encoder module : <ul style="list-style-type: none"> ○ Check encoder module is pushed fully home. ○ Check the encoder wiring is correct.
---	--	--

11.4. Step 4- Motor nameplate data entry.

Action	Additional Information
Select Geared (Induction) motor control <input type="checkbox"/> Set P1-14 to 201 <input type="checkbox"/> Set P4-01 to 0 or 1	Advanced parameter Access. 0 - Geared motors which have the Motor Power Factor available from motor Nameplate. 1 - Geared motors which do not have the Motor Power Factor available.
Enter motor rated voltage (P1-07) <input type="checkbox"/> Enter value into P1-07	Enter Voltage value as shown on the motor nameplate (Volts).
Enter Motor Rated Current (P1-08) <input type="checkbox"/> Enter value into P1-08	Enter Current value as shown on the motor nameplate (Amps).
Enter Motor Rated Frequency (P1-09) <input type="checkbox"/> Enter value into P1-09	Enter Frequency value as shown on the motor nameplate (Hz).
Enter Motor Rated Speed (P1-10) <input type="checkbox"/> Enter value into P1-10	Enter motor rated speed value as shown on the motor nameplate (rpm). The drive display will now show motor speed in estimated rpm. All speed related parameters, such as Minimum and Maximum Speed, run Speeds etc. will also be displayed in Rpm.
Enter the Maximum speed (P1-01) <input type="checkbox"/> Enter value into P1-01	This is the maximum allowable speed in rpm.
Enter Motor power factor Cos ϕ (P4-05) Enter value into P4-05*	Obtained from Motor nameplate *If Motor power factor is unknown use Vector IM speed control instead (P4-01 to a 1).

11.5. Step 5- Motor Auto-tune.

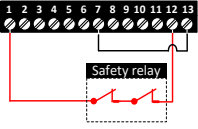
A Motor Auto-tune must be carried out in order to measure the motor electrical characteristics, brakes will be applied by the drive (unless controlled by other means) during this test.

Action	Additional Information
<input type="checkbox"/> If the motor contactor(s) are controlled by the elevator controller then they should be activated to close so that the motor is electrically connected to the drive, otherwise the "Auto-tune" cannot be carried out. <input type="checkbox"/> If the motor contactor(s) are controlled by the drive (connected to relay 1) the motor contactor will automatically be energised when the "Auto-tune" is enabled. Note : For the motor contactor to close the safety chain will need to be closed.	
<input type="checkbox"/> Check Safe Torque off input connections have been made.	 Drive should now show StoP if not see section 19.1.
<input type="checkbox"/> Enable Motor Auto-tune	Set P4-02 to a <u>1</u> and press the  button. <ol style="list-style-type: none"> 1. The motor contactors will close (if controlled by the drive "Relay 1"). 2. The motor brakes will remain applied. 3. The display will show Auto-t. (Test procedure may take several minutes to complete). Once the Auto-tune is completed P4-02 will return to 0 and the display will show StoP (P7-01 thru to P7-06 will be populated). Note: Motor Auto-tune will need to be repeated if the motor, motor cables, motor parameters or drive control mode is changed in P4-01.

11.6. Step 6 - Encoder Setup (If Encoder is installed)

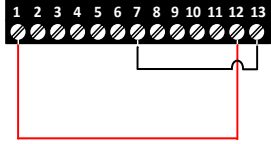
Action		Additional Information
Enter Encoder Resolution	<input type="checkbox"/> Enter encoder pulses per revolution into P6-06	Refer to Encoder datasheet or nameplate.
Check motor direction and encoder direction is correct.	<input type="checkbox"/> During this check you will need to Navigate between parameters P0-25 (Estimated motor speed) and P0-58 (Encoder speed). <input type="checkbox"/> Provide a run-direction command to terminal 2 and run at low speed for a short travel e.g. levelling/10% of motor rated speed, you can Use P1-01 (Maximum speed limit) to limit the motor speed and return back to normal value afterwards. <input type="checkbox"/> Check that the value shown in P0-25 is positive in the Up direction and Negative in the down direction, if it is not then set P4-13 to 1. <input type="checkbox"/> Check that the value in P0-25 and P0-58 match in sign.	➤ If the drive shows <i>! r h i b i t</i> when a run-direction command is given ensure that the Safe Torque off inputs are made. 
<input type="checkbox"/> Enable Encoder	Set P6-05 to 1	Enables Encoder Feedback

➤ Once steps 1 through to 6 above have been performed go to Section 13 Comfort Optimisation

11.7. Enhanced V/F motor Control.

In some cases, older Induction (Geared) motors are not suitable for Vector control (P4-01 = 0 or 1) therefore Enhanced V/F mode can be utilised, it should be noted that in Enhanced V/F mode the speed loop gains **P4-03**, **P4-04**, **P4-15**, **P4-16**, **P4-17** and **P7-13** are not active, furthermore manual adjustment of motor slip compensation (**P1-10**) and *V/F Mode Voltage Boost (P1-11)* maybe required.

Action		Additional Information
Select Geared (Induction) motor control	<input type="checkbox"/> Set P1-14 to 201	Advanced parameter Access.
	<input type="checkbox"/> Set P4-01 to 2	Enhanced V/F Motor control mode.
Enter motor rated voltage (P1-07)	<input type="checkbox"/> Enter value into P1-07	Enter Voltage value as shown on the motor nameplate (Volts).
Enter Motor Rated Current (P1-08)	<input type="checkbox"/> Enter value into P1-08	Enter Current value as shown on the motor nameplate (Amps).
Enter Motor Rated Frequency (P1-09)	<input type="checkbox"/> Enter value into P1-09	Enter Frequency value as shown on the motor nameplate (Hz).
Enter Motor Rated Speed (P1-10)	<input type="checkbox"/> Enter value into P1-10	<p>To ensure that the drive produces full torque it is important that the motor rated speed value as shown on the motor nameplate (rpm) is entered, the value entered is the motor synchronous speed-motor slip speed. E.g. 1450 rpm for a 1500 rpm synchronous speed motor, generally the motor slip value is higher on older motors.</p> <p>if the value is not available then it is possible to practically work out the value :</p> <ol style="list-style-type: none"> Set an estimated motor rated speed in P1-10, e.g. for a 4-pole 50Hz motor then enter 1450rpm. <p>Method 1</p> <ol style="list-style-type: none"> Run the lift (empty) up and down the shaft at levelling speed whilst monitoring the motor speed (via the drive keypad). Adjust P1-10 until the motor speed is the same in both directions. <p>Method 2</p> <ol style="list-style-type: none"> Run the lift in the same direction between a numbers of floors at levelling speed whilst monitoring the current (via the drive keypad). The correct value of P1-10 will be when the lift runs without vibration, whilst achieving the target speed and with the least amount of current. <p>The drive display will now show motor speed in estimated rpm. All speed related parameters, such as Minimum and Maximum Speed, run Speeds etc. will also be displayed in Rpm.</p>
Enter the Maximum speed (P1-01)	<input type="checkbox"/> Enter value into P1-01	This is the maximum allowable speed in rpm.

12. Start-up of Gearless (Permanent Magnet) Motor-With Encoder Feedback.

The below procedure illustrates a method for commissioning the OPTIDRIVE P2 ELEVATOR drive in a typical elevator application, it is assumed the drive has already been mechanically installed.

12.1. Step 1- Wiring Connections.

The below diagram provides guidance for the wiring connections.

More technical information on the electrical wiring is available in section 6 “Electrical Installation” and section 18 “Technical Data”.



Before making any wiring connections ensure that all voltage/power sources are isolated.

12.1.1. Step 1- Wiring Connection diagram.

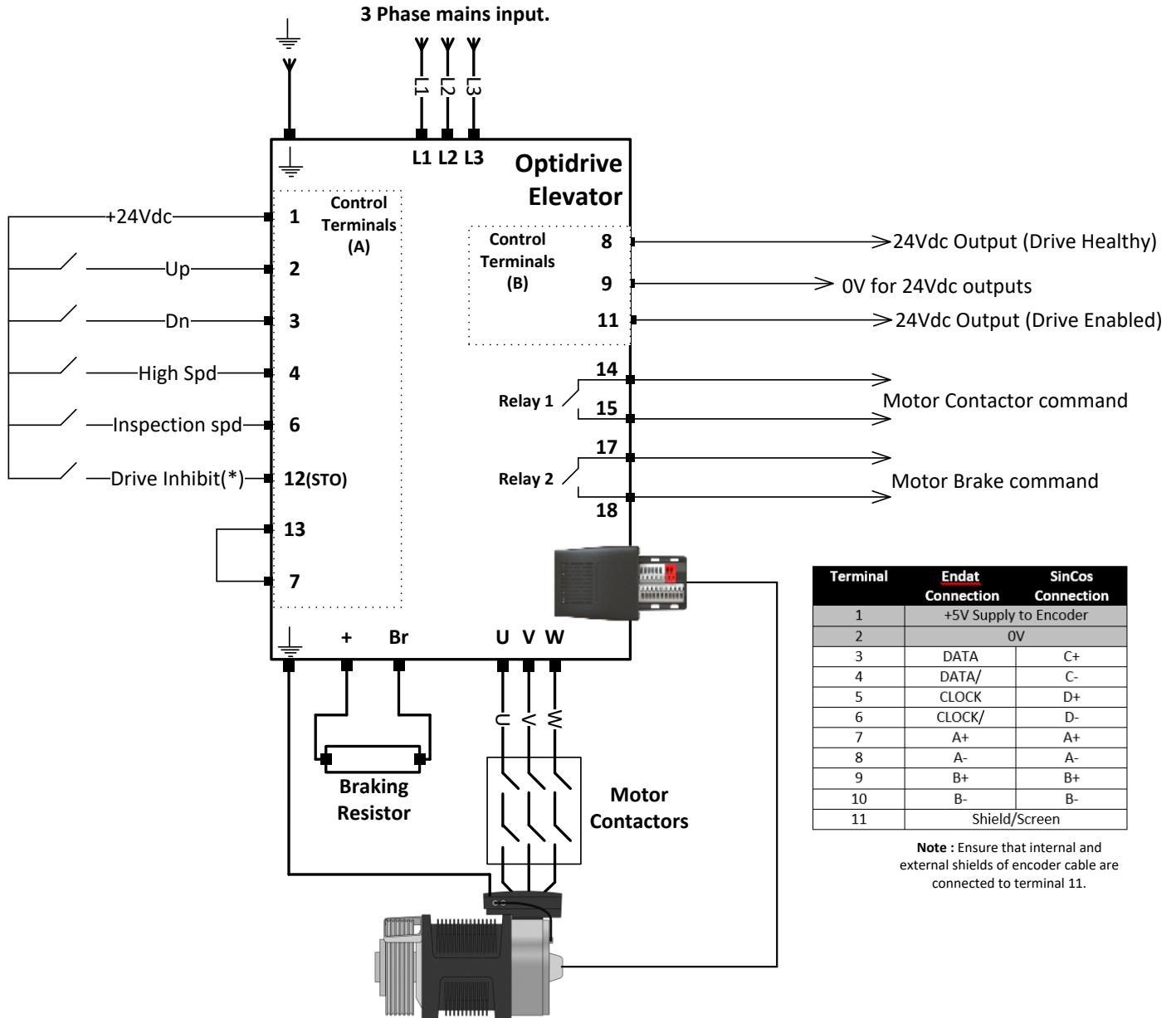

Cable screening/Shield	For Guidance on cable screening/shielding see section 6.1 “Installation in accordance with Good EMC Practice”
Drive Inhibit (*)	From a fast relay connected downstream of the safety chain.
Control Terminals (A)	Default configuration shown, for other configurations see section 6.10.1 “Digital Input Configuration Parameter (P1-13)”
Control Terminals (B)	Default status sources shown for digital outputs (terminal 8 and 11), for other status sources see parameters P2-11 (terminal 8 function) and P2-13
Encoder Module	For Endat Encoder use OPT-2-ENDAT2-IN module. For SinCos Encoder use OPT-2-SINCOS2-IN module.
Braking Resistor	Ensure braking resistor resistance is higher than minimum allowable value for the given drive rating, see section 18.3.

12.2. Step 2- Pre-Power Checks.

	Action/Checks	Additional Information
 <p>Do Not Apply Electrical Power Yet!</p>	<ul style="list-style-type: none"> <input type="checkbox"/> Check that all safety circuits/safety chains are in the correct state, failure to do so could result in damage to the equipment and possible injury or death. <input type="checkbox"/> Check that the intended voltage source matches that of the drive voltage rating. <input type="checkbox"/> Check that any unexpected movement in the motor will not result in damage to equipment / safety risk to persons. <input type="checkbox"/> Check that the elevator controller will not give a start signal to the drive when Electrical power is applied. <input type="checkbox"/> Ideally the Lift car should be balanced (i.e. with brakes off the lift car should not naturally move) and with enough shaft headroom in order to prevent reaching end stops during initial test travels. 	
<p>Check all necessary electrical connections.</p>	<ul style="list-style-type: none"> <input type="checkbox"/> Check Electrical Supply cables are connected to the Input power terminals of the drive. <input type="checkbox"/> Check Motor Cables are connected to the drive U, V, W terminals (If cables have identification markers connect correct phase sequence). <input type="checkbox"/> Check Brake resistor is connected to the "+DC" and "BR" terminals of the drive. <input type="checkbox"/> Check correct control connections are made between the Elevator control panel and the drive. (as detailed in Section 12.1 "Step 1- Wiring Connection diagram.") <input type="checkbox"/> Check correct encoder module (optional) has been installed and the correct connections are made between the drive and the Encoder. 	

12.3. Step 3- Apply Power.



 Apply Electrical Power to the drive	<input type="checkbox"/> Apply rated voltage to the drive. <input type="checkbox"/> Check that the drive displays <i>StoP</i> or <i>Inhibit</i> . <input type="checkbox"/> Check that the Encoder module (Optional) left hand LED light is illuminated Green	<ul style="list-style-type: none"> ➤ If <i>StoP</i> or <i>Inhibit</i> is not shown refer to the troubleshooting section at the back of the user manual. ➤ If there is no green light shown on the encoder module : <ul style="list-style-type: none"> ○ Check encoder module is pushed fully home. ○ Check the encoder wiring is correct.
---	--	--

12.4. Step 4- Motor nameplate data entry.

Action		Additional Information
Select Gearless (Permanent Magnet) motor control mode. (P4-01)	<input type="checkbox"/> Set P1-14 to 201	Advanced parameter Access.
	<input type="checkbox"/> Set P4-01 to 3	Both IPM and SPM type motors are supported.
Enter motor back-EMF voltage value (P1-07)	<input type="checkbox"/> From motor datasheet Enter the Phase to Phase back-EMF value (at motor rated speed). <input type="checkbox"/> If the back-EMF value is not available from the motor datasheet then enter calculated value as shown opposite.	<ul style="list-style-type: none"> ➤ If the back-emf value is not available it can be approximated as per the following calculation : $P1-07 = \text{Motor Rated Power} / \text{Motor Efficiency} / \text{Motor Power factor} / 1.732 / \text{Motor rated Current.}$ <p>(Typical values are 0.95 for Motor efficiency and 0.90 for Motor power factor).</p> <p>Example: Motor rated Power = 7.2kW Motor Efficiency = 0.95, Motor Power factor (Cosϕ) = 0.9, Motor rated current = 16.9A. Therefore: P1-07 = 7200/0.9/0.9/1.732/16.9 = 304V</p> <p>Note:</p> <ol style="list-style-type: none"> 1. Incorrect value can result in abnormal motor operation (motor vibration). 2. For motors \leq 32Hz then the value of P1-07 does not have to be entered (leave at defaults), however the direction check (as shown in Step 6) will not be able to be performed and therefore the motor direction and Encoder direction must be correct.
Enter Motor Rated Current (P1-08)	<input type="checkbox"/> Enter motor rated current into P1-08	Obtained from Motor nameplate (Amps).
Enter Motor Rated Frequency (P1-09)	<input type="checkbox"/> Enter motor rated frequency into P1-09	<ul style="list-style-type: none"> ➤ If not available it can be calculated : motor poles*motor rated rpm/120 <p>Motor Poles (Pair) = P1-09*60/ P1-10, the result must equal a whole number (zero decimal places e.g. 12 and not 12.3) :</p> <p>For non-whole number frequencies e.g. 6.82Hz, then choose next whole number for P1-09 and recalculate accordingly :</p> <p>Next whole number (7)/Pole pairs*60 = New rated speed value (P1-10).</p>
Enter Motor Rated Speed (P1-10)	<input type="checkbox"/> Enter motor rated speed into P1-10	➤ If not available it can be calculated: Motor rated frequency*120/motor poles.
Enter the Maximum speed (P1-01)	<input type="checkbox"/> Enter value into P1-01	This is the maximum allowable speed in rpm.
Set Motor Switching Frequency (P2-24)	<input type="checkbox"/> Set P2-24 to 16kHz	16kHz provides optimum motor control.
Motor Pole Whole number check	<input type="checkbox"/> Confirm that the values set in P1-09 and P1-10 equates to a whole number.	The drive uses P1-09 and P1-10 to calculate the number of motor pole pairs, it is important that the result of the calculation equates to a whole number of poles. (P1-09*60/ P1-10) = Result must be whole number. e.g 16 poles and not 16.3 poles.

12.5. Step 5- Motor Auto-tune.

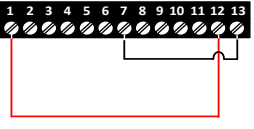
A Motor Auto-tune must be carried out in order to measure the motor electrical characteristics, during the Auto-tune test the motor brakes will be applied by the drive (assuming they are controlled by Relay 2 on the drive).

Action	Additional Information
<input type="checkbox"/> If the motor contactor(s) are controlled by the elevator controller then they should be activated to close so that the motor is electrically connected to the drive, otherwise the "Auto-tune" cannot be carried out. <input type="checkbox"/> If the motor contactor(s) are controlled by the drive (connected to relay 1) the motor contactor will automatically be energised when the "Auto-tune" is enabled. Note: For the motor contactor to close the safety chain will need to be closed.	
<input type="checkbox"/> Check Safe Torque off inputs have been made.	
<input type="checkbox"/> Drive should now show Stop , if not see section 19 "Troubleshooting".	
Enable Motor Auto-tune <input type="checkbox"/> Set P4-02 to a <u>1</u> and press the  button.	<ol style="list-style-type: none"> The motor contactors will close (if controlled by the drive "Relay 1"). The motor brakes will remain applied. The display will show Auto-t. (Test procedure may take several minutes to complete). <p>Once the Auto-tune is completed P4-02 will return to 0 and the display will show Stop (P7-01/03/06 will be populated).</p> <p>Note: Motor Auto-tune will need to be repeated if the motor, motor cables, motor parameters or drive control mode is changed in P4-01.</p>

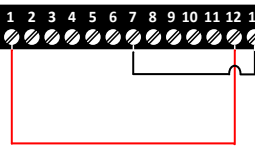

12.6. Step 6- Encoder setup.

Action	Additional Information
Select absolute encoder (Endat or SinCos) (P6-06) <input type="checkbox"/> Enter 65535 into P6-06	65535 value indicates that an Absolute (Endat, SinCos) Encoder is being used.
Check motor direction and encoder direction is correct. <p><i>Note : This step can be skipped if motor direction and Encoder direction are known to be correct)</i></p> <input type="checkbox"/> Note: The below procedure should be performed with a no-load condition (no ropes) or as close to a balanced situation as possible, if this is not the case then the drive may show an error message ("O-I" etc..) when commanded to run, furthermore adjustment maybe required (i.e. increasing P7-14/P7-15) to prevent "SP_Err" trips as per section 15 "Gearless (Permanent Magnet) Motors-Without Encoder (P4-01=3). <input type="checkbox"/> Set P7-14 to 25% and set P7-15 to 10%. <input type="checkbox"/> During this check you will need to Navigate between parameters P0-25 (Estimated motor speed) and P0-58 (Encoder speed) on the drive keypad. <input type="checkbox"/> Provide a run-direction command to terminal 2 and run at low speed (Levelling/10% rated speed) for a short travel, you can Use P1-01 (Maximum speed limit) to limit the motor speed and return back to normal value afterwards. <input type="checkbox"/> During travel Check that the value shown in P0-25 is positive in the Up direction and Negative in the down direction, if it is not then swap phase "V" and "W" and repeat the check. <input type="checkbox"/> Check that the value in P0-25 and P0-58 match in sign. <input type="checkbox"/> Stop the drive. <input type="checkbox"/> Set P7-14 and P7-15 back to 0%.	<p>➤ If the drive shows inhibit when a run-direction command is given ensure that the Safe Torque off inputs are made.</p>  <p>➤ If the motor does not operate as expected or the drive shows an error message refer to section 13 and section 19 "Troubleshooting".</p>
Enable the Encoder (P6-05) <input type="checkbox"/> Set P6-05 to 1	Enables Encoder Feedback and puts the drive into closed loop operation.

12.7. Step 7a- Stationary Encoder offset measurement (Alternative to rotating measurement).

An Encoder Offset measurement (Offset between motor poles and magnets) must be carried when operating a gearless motor.

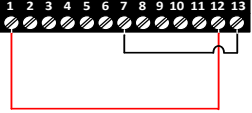
This measurement should be used if the ropes cannot easily be removed from the motor, it should be noted that this measurement is not as accurate as the Rotating Encoder Offset measurement (as per detailed in section 12.8), and may result in higher operating currents.



Action	Additional Information
<input type="checkbox"/> Ensure elevator car is in a no-load balanced position within the shaft (i.e. with brakes off lift car should not naturally move). Failure to do so will risk an incorrect encoder offset value.	
<input type="checkbox"/> Check Safe Torque off inputs have been made.	 <p>Drive should now show Stop if not refer to the troubleshooting section at the back of the user manual.</p>
Stationary Encoder offset measurement	<input type="checkbox"/> Set P4-02 to a <u>2</u> and press the  button. <ol style="list-style-type: none"> 1. The motor contactors will close (if controlled by the drive "Relay 1", and providing the Safety chain is closed), if not controlled by the drive. 2. The motor brakes will remain applied. 3. The display will show Auto-t. (Test procedure may take several minutes to complete). 4. During the measurement the drive will inject a pulsating current into the motor which will give a small sheave movement in order to measure the offset value, therefore it is normal for a pulsing noise to be heard, if this is not the case ensure that the motor contactors are closed and that the encoder is enabled P6-05=1. <p>Note: The amount of movement can be observed in P0-78 (0-360°) and is governed by the setting of P1-08, P4-07 and the strength of the motor brake.</p> <ol style="list-style-type: none"> 5. Once the Auto-tune is completed P4-02 will return to 0 and the display will show Stop and P6-09 (Encoder offset value) will be populated.
<p>Note on Stationary Encoder offset measurement:</p> <ol style="list-style-type: none"> 1. It is recommended that the stationary Encoder offset measurement test is repeated (with motor sheave in different positions) several times to ensure that offset value is correct. 2. The drive and motor current ratings must be correctly matched in order for the stationary encoder offset measurement to be accurate. 3. Offset measurement will need to be repeated if the encoder is changed or mechanically moved. <p>If within repeated tests, the value shown in P6-09 is varying significantly (more than 50°), or always a value of 0 then :</p> <ul style="list-style-type: none"> • Increase P4-07, e.g 200 to 250 (increasing too high will result in overcurrent trips). • If Inconsistent values (with sheave in different positions) are still being measured or nuisance trips are occurring then alternatively : <ol style="list-style-type: none"> 1. Carry out the "Rotating Encoder offset measurement" (ropes-off) as per detailed in section 12.8. or <ol style="list-style-type: none"> 2. Run the drive in open loop as detailed in section 15 "Gearless (Permanent Magnet) Motors-<u>Without</u> Encoder (P4-01=3). During steady state travel the encoder offset value will be displayed in parameter P0-78 index 2 (press up arrow, value shown will be in the range 0-360). 	

➤ Once steps 1 through to 7 above have been performed go to Section 13 Comfort Optimisation.

12.8. Step 7b - Rotating Encoder offset measurement (Alternative to Stationary measurement).

An Encoder Offset measurement (Offset between motor poles and magnets) must be carried out when operating a gearless motor.

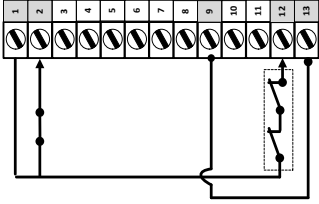
This measurement should be used if the ropes are removed from the motor (if ropes are not removed then perform the Stationary Encoder offset measurement), the rotating measurement is more accurate than the Stationary Encoder Offset measurement and is with the brakes released.

Action	Additional Information
<input type="checkbox"/> Check ropes are removed from motor sheave.	
<input type="checkbox"/> If motor contactor(s) are controlled by the elevator controller check that they are closed.	
<input type="checkbox"/> Check brakes are released.	
<input type="checkbox"/> Enable V/F mode	Set P4-01 to 2
<input type="checkbox"/> Close Safe Torque off input connections	
<input type="checkbox"/> Give a run command to the drive (Close T1 to T2)	
<input type="checkbox"/> Record the Encoder offset value from P0-78. (stabilised value)	Encoder offset value is shown in P0-78 index 2 (press up arrow) in the range 0-360 degrees (Index 2 indicated by lit upper segment)  e.g. 55 degrees Note: <ul style="list-style-type: none"> It is recommended that this test is repeated several times (with motor sheave in different positions) to ensure similar values are obtained (within 50 °). <ul style="list-style-type: none"> The motor sheave should move slightly during the measurement. If motor sheave does not move or similar values are not obtained (following repeated measurements) try increasing P1-11.
<input type="checkbox"/> Disable the drive	E.g. (Open T1 and T2) Drive should now show StoP if not see section 19.1.
<input type="checkbox"/> Enter Encoder offset value	Enter an average of the values that were recorded from P0-78 above into P6-09
<input type="checkbox"/> Enable Gearless (PM) mode	Set P4-01 to 3
<input type="checkbox"/> Enable Motor Auto-tune	<input type="checkbox"/> Set P4-02 to a <u>1</u> and press the  button. <ol style="list-style-type: none"> The motor contactors will close (if controlled by the drive "Relay 1"). The motor brakes will remain applied. The display will show Auto-t. (Test procedure may take several minutes to complete). Once the Auto-tune is completed P4-02 will return to 0 and the display will show StoP (P7-01/03/06 will be populated). Note: Motor Auto-tune will need to be repeated if the motor, motor cables, motor parameters or drive control mode is changed in P4-01.

Note: If the motor phases are swapped or the encoder changed/mechanically moved then repeat the Encoder offset measurement.

➤ Once steps 1 through to 7 above have been performed go to Section 13 Comfort Optimisation.

13. Comfort Optimisation

Note : It is recommended to initially perform the below tests with a lower speed/Maintenance/Inspection speed and load (in balanced condition) and then gradually build up to the required operating speeds and load, Use P1-01 (Max speed limit) to limit the motor speed and return back to normal value afterwards.

13.1. Ramp and travel Jerk Adjustment diagram.

The setting of the speed ramps and travel jerks are detailed in the diagram below and should be adjusted according to the application and prior to setting the speed Loop Gains.

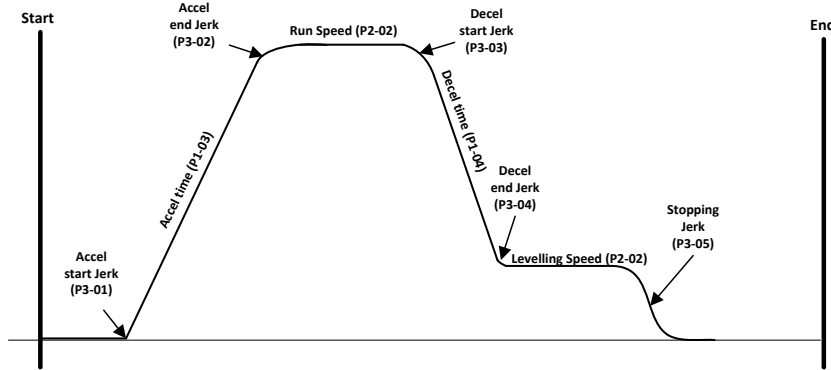

13.2. Speed Loop Gains

The setting of the speed loop gains defines how closely the actual motor speed follows the given speed reference, in the case of an Elevator the correct setting of the speed loop gains is critical in order to provide optimum comfort levels.

The speed loop gains are available in all motor operating modes except “Enhanced V/F IM Speed Control mode” (P4-01=2).

From default the drive has 1 set of speed loop gains enabled, *Proportional Gain (P4-03)* and *Integral Gain (P4-04)*, these 2 gains are active throughout the whole of the travel curve (Start, Travel and Stop).

A further set of speed loop gains, *Low Speed Proportional Gain (P4-15)* and *Low Speed Integral Gain (P4-16)* are also available for situations where a different set of values are required for low speed (Take-off and Levelling) compared to high speed travel, the transition point between the Low speed gains and high speed gains is determined by the value set in parameter P4-17 (*Low speed Gains Transition Point*).

A rollback gain parameter (P7-13) is also available, the rollback gain is generally only required in Gearless applications however it can also be used in Geared systems.

13.2.1. Speed Loop Gains diagram.

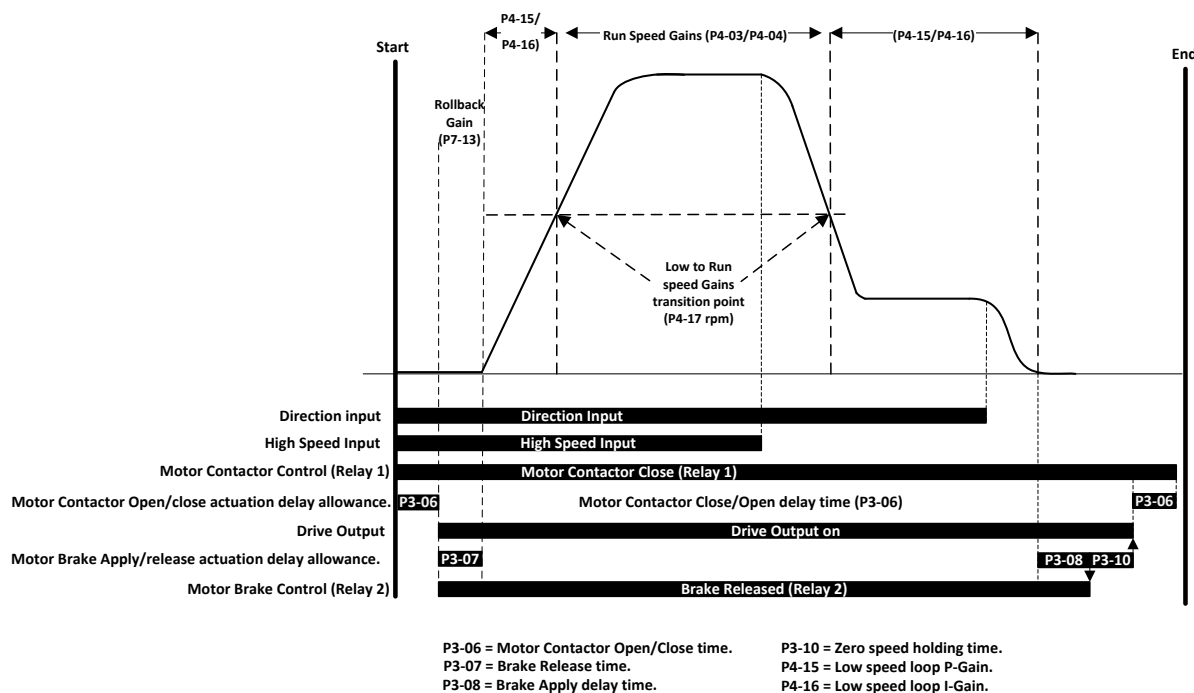

Note: If P4-17 is zero then P4-15 and P4-16 will have no effect.

13.2.2. Speed Loop Gains adjustment for travel.

The optimum method for tuning the speed loop gains is to utilise the PC software Oscilloscope function.

Tuning of the Speed Loop Gains should be performed with varying load conditions (i.e. No load & Full load).

In general the run speed gains should be adjusted as follows:

1. Increase the *Proportional Gain (P4-03)* to achieve the required travel comfort (No speed overshoot when reaching high speed), the upper limitation of the setting will normally show as vibration/Speed Oscillations/Motor noise.
2. Decrease the *Integral Gain (P4-04)* to achieve the required travel comfort, the lower limitation will normally show as speed instability/vibration.

The diagram below shows a typical scenario showing how speed overshoot at the end of the acceleration ramp and speed oscillation during floor approach was solved:

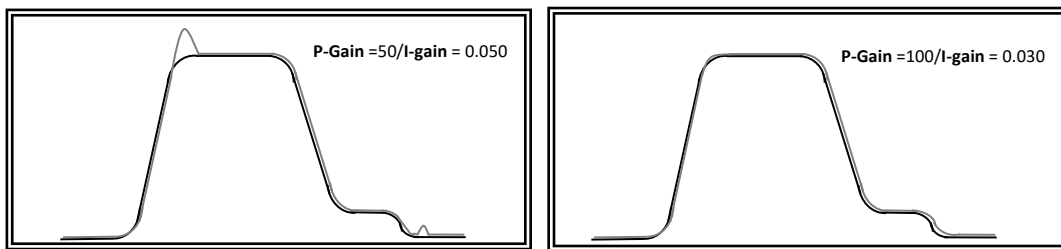

3. If it is found that good travel comfort can be achieved at high speed but not during low speed/levelling then the low speed gains *P4-15 and P4-16* should be utilised.

13.2.3. Rollback Gain adjustment.

If rollback is present during starting (Most common on Gearless motors) then *P7-13 Rollback Control gain* can be utilised.

It is recommended that the rollback gain parameter is adjusted in the worst case situation e.g. elevator car is full and is called upwards and when the elevator car is empty and called downwards.

To reduce the amount of rollback:

1. Increase *P7-13 Rollback Control Gain* until the point where rollback is no longer present, the limit of this setting will in generally show as vibration.
2. If *P7-13* has been increased to the maximum point without vibration but there is still rollback present then increase the brake release time (*P3-07*).
3. If both *P7-13 and P3-07* have been increased and there is still rollback try setting *P7-08 Motor Auto-Pre torque to a 1* (this setting will also reduce the noise during the operation of the rollback function)

The diagram below shows a typical scenario showing how rollback was solved.

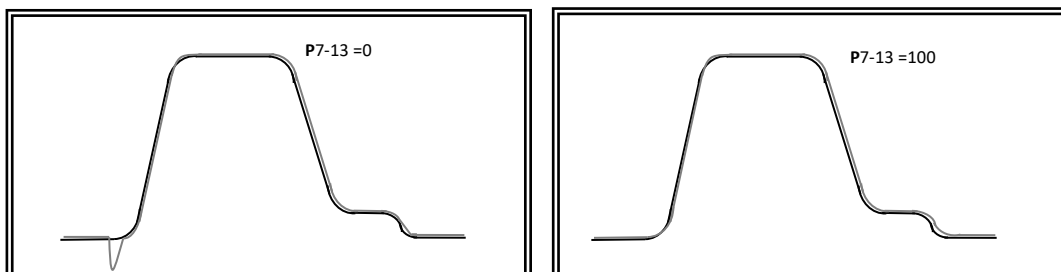

13.3. Comfort Optimisation Procedure.

The below guidance assumes that steps 1 thru to 6 in section 11(Geared)/12 (Gearless) have already been performed.

Action	Guidance				
<input type="checkbox"/> Give a call for the elevator to run at inspection speed.	If P1-13 is at default value (P1-13=0) then inspection speed is defined in parameter P2-04, in this case inspection speed is selected when terminal 6 is high. Alternatively use the maximum speed parameter P1-01 to clamp the speed to a lower value. On Gearless system if the motor is pulled in opposite heavy direction ("SP-Err") then increase P7-13, increasing too high will cause excess current and motor heating. If the drive trips refer to section 19 "Troubleshooting" at the back of the manual.				
<input type="checkbox"/> 1 - Check Starting Comfort	<table border="1"> <tr> <td data-bbox="400 488 555 987"> <input type="checkbox"/> Rollback at start. </td> <td data-bbox="555 488 1522 987"> <ul style="list-style-type: none"> ➤ Ensure correct motor data has been entered and an auto-tune has been performed. ➤ Ensure motor contactor is closing before the drive output is enabled, if controlled by the drive try increasing P3-06. ➤ Try increasing P3-07 (brake release time) allowing a longer period to build-up torque. ➤ P7-13 (Rollback Gain) can also be used if P3-07 has not solved the rollback, if set too high then it will normally show as vibration. (P7-13 Not active when P4-01=2) ➤ On open loop Gearless system try Increasing value in P7-14 (Boost current level) and P7-15 (Torque boost frequency limit), increasing too high will result in excess current (motor stall/overcurrent trips/motor overheating). ➤ Try increasing P7.12 (Magnetising time) by 1.5 to 2x default value. (Not on Gearless) ➤ On Gearless system if rollback cannot be solved with the above try setting P7-08 (Motor auto Pre-torque) to a 1. ➤ On Gearless system If there is noise during the rollback period and is not related to the mechanical brake, try setting P7-08 (Motor auto Pre-torque) to a 1. ➤ If operating in Enhanced V/F mode (P4-01=2) try increasing V/F mode boost (P1-11), increasing too high can result in excess current (motor stall) and motor overheating. </td> </tr> <tr> <td data-bbox="400 987 555 1193"> <input type="checkbox"/> Jerks during starting </td> <td data-bbox="555 987 1522 1193"> <ul style="list-style-type: none"> ➤ Parameter P3-07 defines the actuation time of the motor brakes, generally the default value (0.50sec) is suitable for most situations, if there is a jerk felt during acceleration after brake release then reduce P3-07. ➤ Increasing the value of P3-01 (Accel Start Jerk) can help reduce start jerks. ➤ If jerk is felt after brake is released try adjusting speed loop gains, generally P4-03 is increased. ➤ Also see "Rollback at start" above. </td> </tr> </table>	<input type="checkbox"/> Rollback at start.	<ul style="list-style-type: none"> ➤ Ensure correct motor data has been entered and an auto-tune has been performed. ➤ Ensure motor contactor is closing before the drive output is enabled, if controlled by the drive try increasing P3-06. ➤ Try increasing P3-07 (brake release time) allowing a longer period to build-up torque. ➤ P7-13 (Rollback Gain) can also be used if P3-07 has not solved the rollback, if set too high then it will normally show as vibration. (P7-13 Not active when P4-01=2) ➤ On open loop Gearless system try Increasing value in P7-14 (Boost current level) and P7-15 (Torque boost frequency limit), increasing too high will result in excess current (motor stall/overcurrent trips/motor overheating). ➤ Try increasing P7.12 (Magnetising time) by 1.5 to 2x default value. (Not on Gearless) ➤ On Gearless system if rollback cannot be solved with the above try setting P7-08 (Motor auto Pre-torque) to a 1. ➤ On Gearless system If there is noise during the rollback period and is not related to the mechanical brake, try setting P7-08 (Motor auto Pre-torque) to a 1. ➤ If operating in Enhanced V/F mode (P4-01=2) try increasing V/F mode boost (P1-11), increasing too high can result in excess current (motor stall) and motor overheating. 	<input type="checkbox"/> Jerks during starting	<ul style="list-style-type: none"> ➤ Parameter P3-07 defines the actuation time of the motor brakes, generally the default value (0.50sec) is suitable for most situations, if there is a jerk felt during acceleration after brake release then reduce P3-07. ➤ Increasing the value of P3-01 (Accel Start Jerk) can help reduce start jerks. ➤ If jerk is felt after brake is released try adjusting speed loop gains, generally P4-03 is increased. ➤ Also see "Rollback at start" above.
<input type="checkbox"/> Rollback at start.	<ul style="list-style-type: none"> ➤ Ensure correct motor data has been entered and an auto-tune has been performed. ➤ Ensure motor contactor is closing before the drive output is enabled, if controlled by the drive try increasing P3-06. ➤ Try increasing P3-07 (brake release time) allowing a longer period to build-up torque. ➤ P7-13 (Rollback Gain) can also be used if P3-07 has not solved the rollback, if set too high then it will normally show as vibration. (P7-13 Not active when P4-01=2) ➤ On open loop Gearless system try Increasing value in P7-14 (Boost current level) and P7-15 (Torque boost frequency limit), increasing too high will result in excess current (motor stall/overcurrent trips/motor overheating). ➤ Try increasing P7.12 (Magnetising time) by 1.5 to 2x default value. (Not on Gearless) ➤ On Gearless system if rollback cannot be solved with the above try setting P7-08 (Motor auto Pre-torque) to a 1. ➤ On Gearless system If there is noise during the rollback period and is not related to the mechanical brake, try setting P7-08 (Motor auto Pre-torque) to a 1. ➤ If operating in Enhanced V/F mode (P4-01=2) try increasing V/F mode boost (P1-11), increasing too high can result in excess current (motor stall) and motor overheating. 				
<input type="checkbox"/> Jerks during starting	<ul style="list-style-type: none"> ➤ Parameter P3-07 defines the actuation time of the motor brakes, generally the default value (0.50sec) is suitable for most situations, if there is a jerk felt during acceleration after brake release then reduce P3-07. ➤ Increasing the value of P3-01 (Accel Start Jerk) can help reduce start jerks. ➤ If jerk is felt after brake is released try adjusting speed loop gains, generally P4-03 is increased. ➤ Also see "Rollback at start" above. 				
<input type="checkbox"/> 2 - Travel Comfort during acceleration and High Speed.	<table border="1"> <tr> <td data-bbox="400 1193 555 1552"> <input type="checkbox"/> Vibration at High speed </td> <td data-bbox="555 1193 1522 1552"> <ul style="list-style-type: none"> ➤ Check there are no mechanical problems. ➤ Ensure correct motor data has been entered and an auto-tune has been performed. ➤ On Gearless closed loop system with motor rated frequency >32Hz or open loop Gearless system ensure the motor back EMF voltage is correct, see section 12.4. ➤ If operating in Enhanced V/F mode (P4-01=2) ensure that the magnetising current is not too high, run the car empty in both directions at low/Levelling speed and ensure the current is not >75% motor rated current, adjust P7-04 (Motor magnetising current) accordingly, try reducing further to solve vibration. ➤ Reduce P4-03 (Run speed P-gain) and Increase P4-04 (Run speed I-gain). <p>Further guidance on tuning the speed loop gains is given in section 13.2.</p> </td> </tr> <tr> <td data-bbox="400 1552 555 1695"> <input type="checkbox"/> Jerk as high speed is reached. </td> <td data-bbox="555 1552 1522 1695"> <ul style="list-style-type: none"> ➤ Increase P3-02 (Accel end Jerk) ➤ Increase P4-03 (Run speed P-gain) and reduce P4-04 (Run speed I-gain). <p>Further guidance on tuning the speed loop gains is given in section 13.2.</p> </td> </tr> </table>	<input type="checkbox"/> Vibration at High speed	<ul style="list-style-type: none"> ➤ Check there are no mechanical problems. ➤ Ensure correct motor data has been entered and an auto-tune has been performed. ➤ On Gearless closed loop system with motor rated frequency >32Hz or open loop Gearless system ensure the motor back EMF voltage is correct, see section 12.4. ➤ If operating in Enhanced V/F mode (P4-01=2) ensure that the magnetising current is not too high, run the car empty in both directions at low/Levelling speed and ensure the current is not >75% motor rated current, adjust P7-04 (Motor magnetising current) accordingly, try reducing further to solve vibration. ➤ Reduce P4-03 (Run speed P-gain) and Increase P4-04 (Run speed I-gain). <p>Further guidance on tuning the speed loop gains is given in section 13.2.</p>	<input type="checkbox"/> Jerk as high speed is reached.	<ul style="list-style-type: none"> ➤ Increase P3-02 (Accel end Jerk) ➤ Increase P4-03 (Run speed P-gain) and reduce P4-04 (Run speed I-gain). <p>Further guidance on tuning the speed loop gains is given in section 13.2.</p>
<input type="checkbox"/> Vibration at High speed	<ul style="list-style-type: none"> ➤ Check there are no mechanical problems. ➤ Ensure correct motor data has been entered and an auto-tune has been performed. ➤ On Gearless closed loop system with motor rated frequency >32Hz or open loop Gearless system ensure the motor back EMF voltage is correct, see section 12.4. ➤ If operating in Enhanced V/F mode (P4-01=2) ensure that the magnetising current is not too high, run the car empty in both directions at low/Levelling speed and ensure the current is not >75% motor rated current, adjust P7-04 (Motor magnetising current) accordingly, try reducing further to solve vibration. ➤ Reduce P4-03 (Run speed P-gain) and Increase P4-04 (Run speed I-gain). <p>Further guidance on tuning the speed loop gains is given in section 13.2.</p>				
<input type="checkbox"/> Jerk as high speed is reached.	<ul style="list-style-type: none"> ➤ Increase P3-02 (Accel end Jerk) ➤ Increase P4-03 (Run speed P-gain) and reduce P4-04 (Run speed I-gain). <p>Further guidance on tuning the speed loop gains is given in section 13.2.</p>				

Continued over...

<input type="checkbox"/> 3 - Travel Comfort at Levelling speed/Low speed	<input type="checkbox"/> Vibration at low speed.	<ul style="list-style-type: none"> ➤ Check there are no mechanical problems. ➤ Confirm that the drive is not operating in current limit (Flashing dots on Display) if it is then reduce load/confirm correct motor data has been entered. ➤ On Gearless closed loop system with motor rated frequency >32Hz or open loop operation ensure the motor back EMF voltage is correct, see section 12.4. ➤ If it is found that the travel comfort is good at high speed but poor at Levelling speed then the low speed gains can be utilised. ➤ If low speed gains (P4-16 & P4-17) are not being used then reduce P4-03 (Run speed P-gain) and Increase P4-04 (Run speed I-gain). ➤ If low speed gains (P4-16 & P4-17) are being used then reduce P4-16 (Low speed P-gain) and Increase P4-17 (Low speed I-gain) <p>Further guidance on tuning the speed loop gains is given in section 13.2.</p> <ul style="list-style-type: none"> ➤ If operating in Enhanced V/F mode (P4-01=2) confirm that the motor rated speed in P1-10 is set correctly, as detailed in 11.7. ➤ If operating in Enhanced V/F mode (P4-01=2) try reducing P1-07 (Motor rated Voltage), also the V/F characteristic (P4-10/P4-11) may need adjustment.
<input type="checkbox"/> 4 - Stopping Comfort	<input type="checkbox"/> Bump felt when stopping	<ul style="list-style-type: none"> ➤ Ensure motor contactor is not opening before the drive output is disabled/Brake applied, if controlled by the drive try increasing P3-06. ➤ Increase P3-10 (Zero speed holding time on disable). ➤ If a brake apply speed (P3-09) has been set reduce the value.
	<input type="checkbox"/> Noise when the motor brake applies (due to instant removal of torque).	<ul style="list-style-type: none"> ➤ In Gearless applications (P4-01=3) Increase P3-19 (Torque reduction during stopping), parameter P3-10 (Zero speed holding time on disable) can also be increased to give further improvement.
	<input type="checkbox"/> If the motor is pulled in the opposite direction during stopping (due to the overhauling effect of the load)	<ul style="list-style-type: none"> ➤ Increase P4-03 (Run speed P-gain) or P4-16 (Low speed P-gain) if low speed gains are being used. <p>Further guidance on tuning the speed loop gains is given in section 13.2.</p> <ul style="list-style-type: none"> ➤ Check P3-19 is not set too high resulting in torque loss prior to stopping.
<input type="checkbox"/> 5 - Floor Level Accuracy	<input type="checkbox"/> Check that car is landing at the floor level.	<ul style="list-style-type: none"> ➤ Ensure the correct motor data has been entered and an auto-tune has been performed. ➤ If operating in Enhanced V/F mode (P4-01=2) and the car is not reaching the floor ensure there is suitable low-speed torque, try increasing V/F mode boost (P1-11), increasing too high can result in excess current (motor stall) and motor overheating. ➤ If the car is not reaching the floor try increasing P2-02 (levelling speed)/ P3-05 (Stopping jerk). ➤ If the car is overshooting the floor decrease P2-02 (levelling speed)/ P3-05 (Stopping jerk). ➤ If operating in Enhanced V/F mode (P4-01=2) confirm that the motor rated speed in P1-10 is set correctly, as detailed in section 11.7. ➤ Ensure speed loop gains are optimally tuned so that the speed following error is minimised Increase P4-03 (Run speed P-gain) and reduce P4-04 (Run speed I-gain) or if using the low speed gains increase P4-16 (Low speed P-gain) and reduce P4-17 (Low speed I-gain). <p>Further guidance on tuning the speed loop gains is given in section 13.2.</p>

14. Advanced Features

14.1. Short Floor Operation

In a normal elevator travel profile the drive will be travelling at the Run Speed when the levelling input is received (essentially, the Run Speed input is removed). If the levelling input (run speed input removed) is received prior to the drive having reached the Run Speed (e.g. whilst still accelerating) the Short floor operation will work to reduce the Elevator travel time by automatically adjusting the speed to reach the floor in a shorter time.

14.1.1. Normal Elevator travel profile

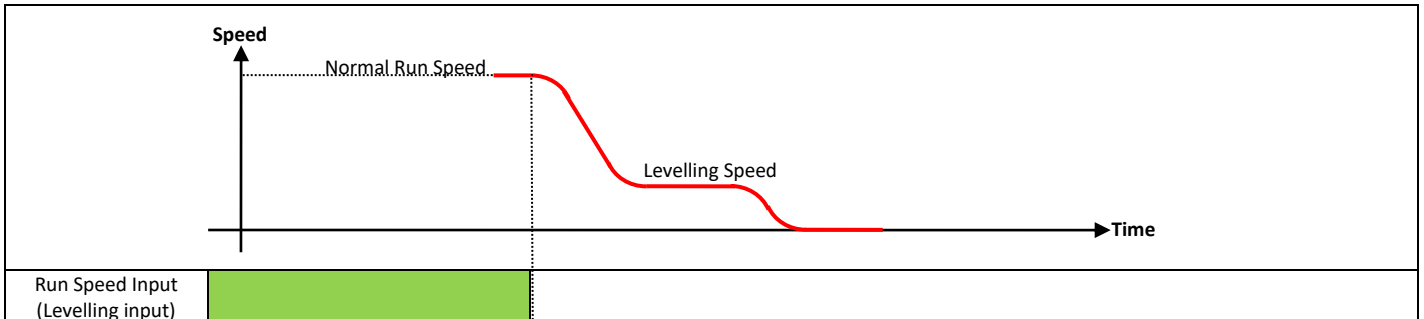

14.1.2. Short Floor profile

Short floor operation is enabled by setting parameter P3-11 to 1, once set the drive will operate as follows:

If the Output Frequency is > 40% of Run Speed when levelling Input received

In this case, the drive will hold the present output frequency for the time period calculated (Line A) based on the travel distance from Run Speed to the present output frequency, before decelerating to the levelling speed.

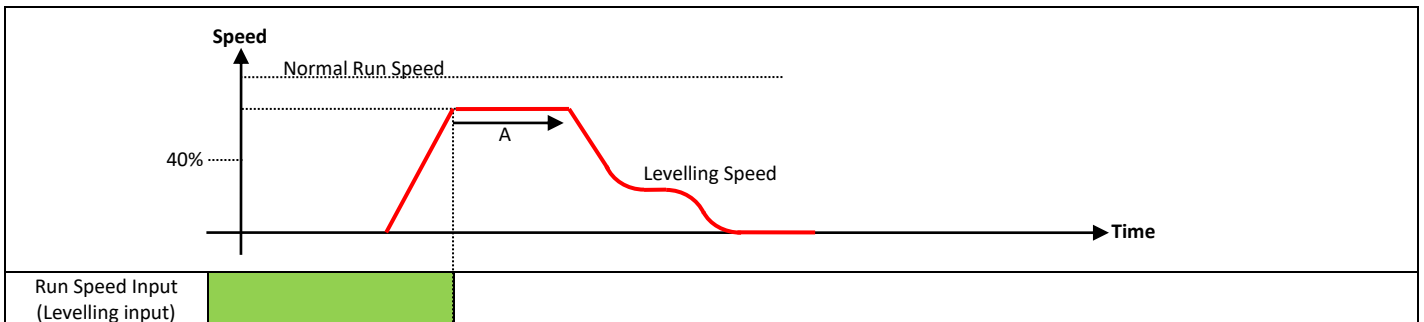

If the Output Frequency Output Frequency is < 40% of Run Speed when levelling Input received

In this case, the drive will accelerate to 40% of the Run Speed, and maintain this frequency for a time period calculated (Line A) based on the travel distance from Run Speed to the present output frequency, before decelerating to the levelling speed.

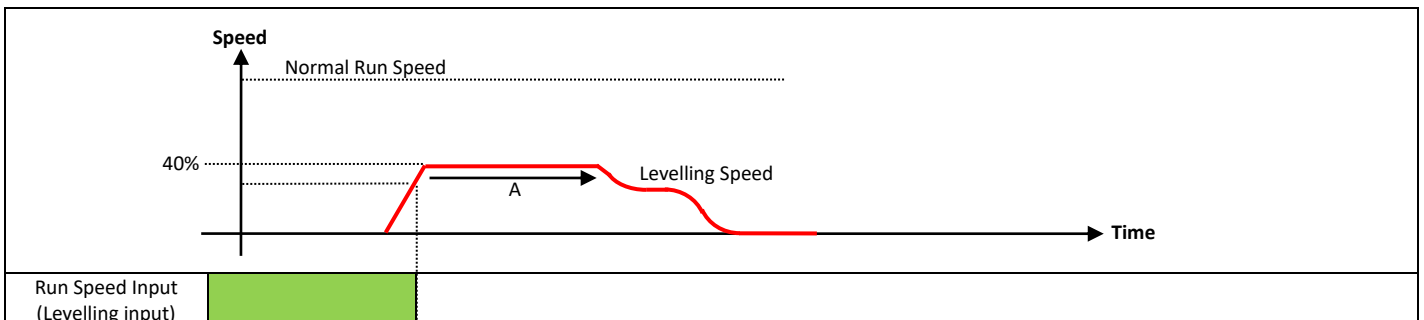

14.2. Rescue Mode Operation (UPS Power Supply)

Rescue mode allows the drive (400V 3Ø drives only) to be operated from a single phase 230V AC UPS (Uninterruptible power supply) so that in an emergency situation (Passenger evacuation) the elevator car can still be operated at a limited speed, for example in the event of a mains Bourne power failure.

Rescue mode is automatically activated when:

1. The 3 phase supply is removed and after a delay of 5 seconds the UPS supply is connected to L1 and L2 terminals.
2. The UPS supply voltage is within the range of 205VAC and 280VAC.
3. P1-13 is set to 7 and T10 is high, see section 6.10.1 for more details.

Note : Normal (3 phase) operation is resumed following a power cycle (and T10 is low if P1-13=7).

Rescue mode operation can be monitored via a digital output by setting P2-13 to a 6 (Rescue Mode Active):

- Digital output 2 (terminal 11) will be Logic 1 (24V) when the drive is operating in Rescue Mode.

During Rescue Mode Operation the direction of travel can be shown on the display by pressing the  button, it is assumed that when a Run up (Forward) command (Terminal 2 closed) is given the motor rotates clockwise (looking at the motor with the sheave facing you).

14.2.1. Dimensioning the UPS

The UPS must be of the following type.

Output Voltage	VA Rating
1 Phase 200 – 240 Volt - Sine Wave Output.	>= 230 x Motor Rated Current P1-08
Simulated Sine Wave UPS also supported providing the voltage range is within that set out in section 18.2.2 Rescue Mode (UPS) supply.	

14.2.2. UPS Connection Diagram

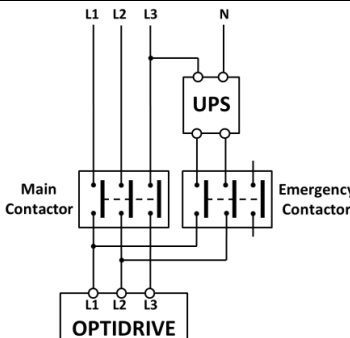

Note

- The Emergency Contactor can only be closed when the Main Contactor is open.
- A delay time of no less than 5 sec’s must be included when changing over to/from UPS supply to/From mains supply mode.
- The Main Contactor and Emergency Contactor must be interlocked so that both cannot be energised at the same time, failure to do so may result in damage to the UPS, contactor.

14.2.3. Rescue Mode speed control

Par	Parameter Name	Minimum	Maximum	Default	Units
P3-12	Rescue Operation Function	0	3	0	-
	0: Basic Rescue mode				
	1: Light Load Detection				
	2: Reserved – Do Not use.				
	3: UPS Easiest direction based on load measurement				

P3-12 = 0 (Basic rescue mode)

- The Speed is defined by the rescue mode speed parameter P2-05 (Limited internally to 10Hz to prevent nuisance Under Voltage (“U- uoL t”) trips due to excess power draw/voltage drop from the UPS at higher speeds).
- Travel Direction is governed by the direction command given to the drive.

P3-12= 1 (Light Load detection)

- The Speed during the light load test is defined by the rescue mode speed parameter P2-05 (Default 5.0Hz).
- Travel direction is decided by the light load detection test result and not the direction input, the test measures which direction is the easiest direction in order to provide longevity of the UPS and ensure a floor is reached before the UPS is exhausted.
- The light detection always starts in the downward direction (motor anti-clockwise with sheave facing you).

Direction command

Motor Speed (light direction learning)

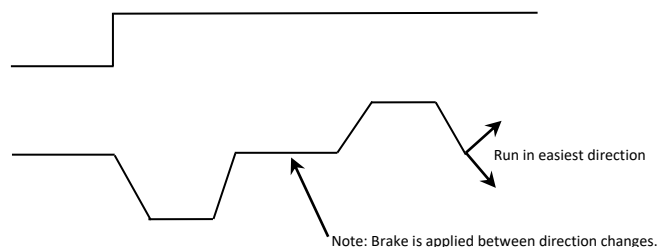

P3-12 = 3 (UPS Easiest direction based on Load measurement)

- In this mode the direction of travel is controlled by the drive, the travel direction is based on the direction which consumed the least amount of load (Load measurement) when the drive was last enabled with mains 400V supply operation.
- The load measurement is performed during the Motor Brake Release Time (P3-07).
- The accuracy of the load measurement depends on the application specifics, accuracy can be improved by increasing the measurement time (P3-07).
- The outcome of the load measurement can be monitored in parameter P0-62 (0 = easiest direction is Upwards, 1 = easiest direction is Downwards, 2 = Balanced).
- If the load measurement could not be performed (balanced load situation) then the drive will instead :
 - Switch to P3-12= 1 (Light Load detection test) in Geared (Induction) systems.
 - Switch to P3-12 = 0 (direction from controller) in gearless systems.

14.2.4. Rescue Mode speed limitation and tuning.

The actual speed will be limited depending on the drives internal DC bus voltage level as shown in the below calculation.

$$\text{Rescue Mode Speed Limit} = \frac{\text{DC Bus Voltage (P0-20)} \times \text{Motor Rated Frequency (P1-09)}}{1.7 \times \text{Motor Rated Voltage (P1-07)}}$$

It should also be noted that the level of motor load will affect the available DC bus Voltage; in some cases (More likely on Geared (Induction) Motors) it may be necessary to reduce the Rescue Speed further in order to prevent nuisance Under Voltage (“U-UDLT”) trips.

Rescue mode P-gain (P7-17) is available for adjustment to improve speed stability during rescue operation.

14.3. Motor presence check before opening mechanical brake.

To ensure that the motor is connected, the drive has a function which checks that at each start command all 3 phases of the motor (Geared (Induction) and Gearless) are connected prior to releasing the electro-mechanical brake.

Par	Parameter Name	Minimum	Maximum	Default	Units
P3-18	Motor Connected Check	0.0	100.00	15	%
	This value (% of motor rated current) must be achieved before the brake is released, if not then it is assumed the motor is not connected and the drive will trip “DUE-PH” or “DUE-F” (size 2). If P3-18 is set to a value of zero then the motor connected check function is disabled.				

The default value of 15 is in general suitable for most applications, this value can be reduced in order to reduce the audible noise when the test is performed, an exact value is one in which the audible noise level is acceptable but the drive still detects each of the motor phases should they not be connected.

14.4. Motor brake release monitoring

Terminal 18 and 19 of the OPT-2-ENDAT2-IN and OPT-2-SINCOS2-IN encoder interface modules can be used to monitor (With Brake micro switches) and verify the mechanical brake dropping mechanism after each brake release/Apply (as commanded by Relay 2 of the drive), and if verification fails then the drive will trip and prevent the drive reacting to any further run commands, once the trip occurs then it can only be reset by a “competent person” and not by a normal trip reset or power cycle.

14.4.1. Connection Method

The diagrams below shows how normally closed brake micro switches are connected to the encoder interface module.



14.4.2. Parameter setup.

1. Ensure the connections above have been made.
2. Set the following parameters :
 - P6-11 to “t18t19“(Brake release monitoring using terminal 18 and 19 of Encoder module).
 - P6-12 (In sec’s) to represent the expected time between the brake being released/applied (Relay 2) and the brake micro switches changing state.

14.4.3. Related Parameters.

Par	Parameter Name	Minimum	Maximum	Default	Units
P6-11	Brake Release-monitoring terminal Enable	Off	t18t19	OFF	-
	OFF: Brake release monitoring Disabled. Din-1..Din-5 t18t19: T18 & T19 of Encoder module (OPT-2-ENDAT2-IN/ OPT-2-SINCOS2-IN) used for monitoring brake micro switches.				
P6-12	Brake Release- monitoring time	0.1	5.0	0.5	Sec’s
	If the monitoring terminal has not changed state in this time (since the brake has been released by relay 2 of the drive) then the drive will trip “bF-Err” or “bF-LoC” (if number of attempts as set in P6-13 has been met)				
P6-13	Brake Release-number of errors before lockout	0	5	0	-
	Number of brake release monitoring errors before permanent trip “bF-LoC” is displayed.				
Note :	If Parameter P2-36 is set to 'RULt0-0' then the drive will automatically reset the “bF-Err” message, otherwise the trip will have to be reset manually e.g. Enable/direction input toggled.				

14.4.4. Method of Operation

When the function (mechanical brake release monitoring) is enabled, the drive will monitor terminal 18 & 19 of the encoder module and check that each time the brake is commanded to open/close the micro-switches change to the correct state within a set time (P6-12), if the state is incorrect then the drive will display the warning message “bF-Err” , reset and have another attempt, if after the number of attempts (as set in P6-13) the brake micro switches are indicating the incorrect state then the drive will permanently show the error message “bF-LoC”.

Before the lift is put into service, test runs should be performed to ensure that the function works as expected.

In the instance of the permanent error message “bF-LoC” being shown, then it can be cleared as follows:

1. Disable drive.
2. Set P6-11 to Off.
3. Press Mode button.
4. Set P6-11 back to “t18t19”.

14.4.5. Checking for correct Operation

Once the relevant parameters have been programmed (as detailed above) then the “Brake release monitoring” function should be verified for correct operation, this can be carried out by exercising the micro switches/monitoring input (during a low speed run) to simulate the brake not releasing/closing and checking that the “bF-Err”/“bF-LoC” error message/s is shown.

15. Gearless (Permanent Magnet) Motors-Without Encoder (P4-01=3).

Open loop operation of a gearless (PM) motor is intended as a method of motor operation without an encoder, this allows for a means of confirming that the motor direction and encoder signal direction matches during first start-up of the elevator system, furthermore this function can be used to bring the elevator car to a required position in the shaft should the encoder feedback be lost, it should be noted that the motor control performance will not be as per Closed loop operation.

In all applications, to ensure good performance and safe control over the motor and connected load, it is essential to ensure that the drive parameters are adjusted to suit the connected motor. Following this, an autotune **must** be carried out, this allows the drive to measure the data required for correct control of the connected motor.



Whilst the autotune procedure does not rotate the motor shaft, the motor shaft may still turn if the motor holding brake is not applied. It is not normally necessary to uncouple the load from the motor; however the user should ensure that no risk arises from the possible movement of the motor shaft.

15.1. Step 1- Wiring Connections.

- Make wiring connections as per detailed in section 12.1 “Step 1- Wiring Connections.” But without making encoder connections.

15.2. Step 2- Pre-Power Checks.

- Perform Pre-Power checks as per detailed in section 12.2 “Step 2- Pre-Power Checks.”

15.3. Step 3- Apply Power.

 Apply Electrical Power to the drive	<input type="checkbox"/> Apply rated voltage to the drive. <input type="checkbox"/> Check that the drive displays <i>StoP</i> or <i>inhib it</i> .	➤ If <i>StoP</i> or <i>inhib it</i> is not shown refer to the troubleshooting section at the back of the user manual.
--	---	---

15.4. Step 4- Motor nameplate data entry.

	Action	Additional Information
Select Gearless (Permanent Magnet) motor control mode	Set P1-14 to 201	Advanced Parameter Access.
	Set P4-01 to 3	Both IPM and SPM type motors are supported.
<input type="checkbox"/> Enter motor back-EMF voltage value	<input type="checkbox"/> From motor datasheet Enter the Phase to Phase back-EMF value (at motor rated speed). <input type="checkbox"/> If the back-EMF value is not available from the motor datasheet then enter calculated value as shown opposite.	➤ If the back-emf value is not available it can be approximated as per the following calculation : $P1-07 = \text{Motor Rated Power} / \text{Motor Efficiency} / \text{Motor Power factor} / 1.732 / \text{Motor rated Current}$ (Typical values are 0.95 for Motor efficiency and 0.90 for Motor power factor). Example: Motor rated Power = 7.2kW Motor Efficiency = 0.95, Motor Power factor (CosØ) = 0.9, Motor rated current = 16.9A. Therefore: $P1-07 = 7200 / 0.9 / 0.9 / 1.732 / 16.9 = \mathbf{304V}$ Note: Incorrect value can result in abnormal motor operation (motor vibration).
<input type="checkbox"/> Enter Motor Rated Current	Enter value into P1-08	Obtained from Motor nameplate (Amps).
<input type="checkbox"/> Enter Motor Rated Frequency	Enter value into P1-09	Note: The drive uses P1-09 to calculate the number of motor pole pairs. Motor Poles (Pair) = $P1-09 * 60 / P1-10$, the result must equal a whole number (zero decimal places e.g. 12 and not 12.3) : For non-whole number frequencies e.g. 6.82Hz, then choose next whole number for P1-09 and recalculate accordingly : Next whole number (7)/Pole pairs*60 = New rated speed value (P1-10).
<input type="checkbox"/> Enter Motor Rated Speed	Enter value into P1-10	Obtained from Motor nameplate (rpm)
<input type="checkbox"/> Set Motor Switching Frequency	Set P2-24 to 16kHz	16kHz provides optimum motor control.
<input type="checkbox"/> Set PM Motor boost values	Set P7-14 to 25%	Boost Current Level
	Set P7-15 to 10%	Boost Frequency

15.5. Step 5- Motor Auto-tune.

A Motor Auto-tune must be carried out in order to measure the motor electrical characteristics, during the Auto-tune test the brakes will be applied by the drive (unless controlled by other means).

Action	Additional Information
<p><input type="checkbox"/> If the motor contactor(s) are controlled by the elevator controller then they should be activated to close so that the motor is electrically connected to the drive, otherwise the "Auto-tune" cannot be carried out.</p> <p><input type="checkbox"/> If the motor contactor(s) are controlled by the drive (connected to relay 1) the motor contactor will automatically be energised when the "Auto-tune" is enabled.</p> <p>Note: For the motor contactor to close the safety chain will need to be closed.</p>	
<p><input type="checkbox"/> Close Safe Torque off input connections</p>	<div data-bbox="379 472 580 600" data-label="Diagram"> </div> <p data-bbox="735 477 1270 510">Drive should now show Stop if not see section 19.1.</p>
<p><input type="checkbox"/> Enable Motor Auto-tune</p>	<p data-bbox="336 734 683 790">Set P4-02 to a <u>1</u> and press the  button.</p> <ol data-bbox="735 629 1458 745" style="list-style-type: none"> 1. The motor contactors will close (if controlled by the drive "Relay 1"). 2. The motor brakes will remain applied. 3. The display will show Auto-t. (Test procedure may take several minutes to complete). <p data-bbox="735 768 1473 831">Once the Auto-tune is completed P4-02 will return to 0 and the display will show Stop (P7-01/03/06 will be populated).</p> <p data-bbox="735 835 1485 898">Note: Motor Auto-tune will need to be repeated if the motor, motor cables, motor parameters or drive control mode is changed in P4-01.</p>

Once steps 1 through to 5 above have been performed go to section 13 Comfort Optimisation.

16.Parameters

16.1. Parameter Set Overview

The Optidrive P2 Elevator drive Parameter set consists of 6 groups as follows:

- Group 0 – Read Only Monitoring Parameters.
- Group 1 – Speed Limits, Basic motor data, Command Source.
- Group 2 – Travel Speeds, I/O setup.
- Group 3 – S-ramps, Output contactor/Brake, Short floor, Light load detection.
- Group 4 – Motor Control Modes, Speed Loop Gains, Current Limits.
- Group 5 – Modbus, CAN Open Communication.
- Group 6 – Encoder setup, Brake Release Monitoring.
- Group 7 – Motor Measured data, Rollback gains.
- Group 8 & 9 – Application specific/User Configurable I/O (See Optitools studio PC software for further information)

When the Optidrive P2 Elevator drive is reset to factory defaults, or is in its factory supplied state, only Group 1 Parameters can be accessed. In order to allow access to parameters from the higher level groups, P1-14 must be set to the same value as P2-40 (Default setting = 101). With this setting, parameter groups 1 – 5 can be accessed, along with the first 50 parameters in Group 0. (Enter 201 in P2-40 for access to Group 6 and above).

16.2. Parameter Group 1 – Speed Limits, Basic motor data, Command Source.

Par	Parameter Name	Minimum	Maximum	Default	Units
P1-01	Maximum Frequency / Speed Limit (Also speed 8 if Multispeed selection P1-13 = 6 is used – see section 6.10.1)	P1-02	500.0	50.0 (60.0)	Hz / Rpm
	Maximum output frequency or motor speed limit – Hz or rpm. If P1-10 >0, the value entered / displayed is in Rpm				
P1-02	Minimum Frequency / Speed Limit	0.0	P1-01	0.0	Hz / Rpm
	Minimum speed limit – Hz or rpm. If P1-10 >0, the value entered / displayed is in Rpm				
P1-03	Acceleration Ramp Time	0.00	600	2.0	Seconds
	Acceleration ramp time in seconds. (Detailed in section 21.2)				
P1-04	Deceleration Ramp Time	0.00	600	2.0	Seconds
	Deceleration ramp time in seconds. (Detailed in section 21.2)				
P1-07	Motor Rated Voltage/Back EMF-PM Motors	Drive Rating Dependent			Volts
	This parameter should be set to the rated (nameplate) voltage of the motor (Volts)/Phase to Phase back emf voltage at rated speed.				
P1-08	Motor Rated Current	Drive Rating Dependent			Amps
	This parameter should be set to the rated (nameplate) current of the motor				
P1-09	Motor Rated Frequency	5	250	50 (60)	Hz
	This parameter should be set to the rated (nameplate) frequency of the motor				
P1-10	Motor Rated Speed	0	15000	0	Rpm
	This parameter can optionally be set to the rated (nameplate) rpm of the motor. When set to the default value of zero, all speed related parameters are displayed in Hz, and the slip compensation for the motor is disabled. Entering the value from the motor nameplate enables the slip compensation function, and the Optidrive P2 Elevator drive display will now show motor speed in estimated rpm. All speed related parameters, such as Minimum and Maximum Speed, Run Speeds etc. will also be displayed in Rpm. Note: When the drive is operated with the optional Encoder Feedback Interface, this parameter must be set to the correct nameplate Rpm of the connected motor.				
P1-11	V/F Mode Voltage Boost	0.0	Drive Rating Dependent		%
	Voltage boost is used to increase the applied motor voltage at low output frequencies, in order to improve low speed and starting torque. Excessive voltage boost levels may result in increased motor current and temperature, and force ventilation of the motor may be required. An automatic setting (AUTO) is also possible, whereby the Optidrive P2 Elevator drive will automatically adjust this parameter based on the motor parameters measured during an autotune.				
P1-12	Primary Command Source Mode	0	6	0	-
	0: Terminal Control. The drive responds directly to signals applied to the control terminals. 1: Uni-directional Keypad Control. The drive can be controlled in the forward direction only using an external or remote Keypad 2: Bi-directional Keypad Control. The drive can be controlled in the forward and reverse directions using an external or remote Keypad. Pressing the keypad START button toggles between forward and reverse. 3: Terminal Control. The drive responds directly to signals applied to the control terminals. 4: Fieldbus Control. Control via Modbus RTU if no fieldbus interface option is present, otherwise control is from the fieldbus option module interface 6: CAN bus Control. Control via CAN bus connected to the RJ45 serial interface connector				
P1-13	Digital Inputs Function Select	0	7	1	-
	Defines the function of the digital inputs depending on the control mode setting in P1-12. See section 6.10.1 for more information.				
P1-14	Extended Menu Access Code	0	30000	0	-
	Parameter Access Control. The following settings are applicable : P1-14 = P2-40 = 101 : Allows access to Parameter Groups 0 – 5				

16.3. Parameter Group 2 – Travel Speeds, I/O setup.

Par	Parameter Name	Minimum	Maximum	Default	Units
P2-01	Levelling Speed	0.0	P1-01	5.0	Hz / Rpm
P2-02	High Speed	0.0	P1-01	50.0	Hz / Rpm
P2-03	Intermediate Speed	0.0	P1-01	25.0	Hz / Rpm
P2-04	Inspection Speed	0.0	P1-01	5.0	Hz / Rpm
P2-05	Rescue Mode Speed (400V three phase input drives only)	0.0	*P1-09	5.0	Hz / Rpm
P2-06	High Speed 2	1.0	P1-01	5.0	Hz / Rpm
P2-07	High Speed 3	0.2	5.0	1.0	Hz / Rpm
P2-08	Reserved- Do not use	-	-	-	-
Speeds / Frequencies are selected by digital inputs depending on the setting of P1-13.(see section 6.10.1) If P1-10 = 0, the values are entered as Hz. If P1-10 > 0, the values are entered as Rpm. *Limited to 10.0Hz internally.					
P2-11	Analog / Digital Output 1 (Terminal 8) Function Select Digital Output Mode. Logic 1 = +24V DC 0: Drive Enabled (Running). Logic 1 when the Optidrive P2 Elevator drive is enabled (Running) 1: Drive Healthy. Logic 1 When no Fault condition exists on the drive. ("inH" is not included as a fault) 2: At Target Frequency (Speed). Logic 1 when the output frequency matches the setpoint frequency 3: Output Frequency > 0.0. Logic 1 when the motor runs above zero speed 4: Output Frequency >= Limit. Logic 1 when the motor speed exceeds the adjustable limit 5: Output Current >= Limit. Logic 1 when the motor current exceeds the adjustable limit 6: Motor Torque >= Limit. Logic when the motor torque exceeds the adjustable limit 7: STO Status. Logic 1 when both STO inputs are present and the drive is able to be operated. Note: When using settings 4 – 6, parameters P2-16 and P2-17 must be used together to control the behaviour. The output will switch to Logic 1 when the selected signal exceeds the value programmed in P2-16, and return to Logic 0 when the signal falls below the value programmed in P2-17. Analog Output Mode 8: Output Frequency (Motor Speed). 0 to P1-02 9: Output (Motor) Current. 0 to 200% of P1-08 10: Motor Torque. 0 to 200% of motor rated torque 11: Output (Motor) Power. 0 to 200% of drive rated power	0	11	1	-
P2-12	Analog Output 1 (Terminal 8) Format U 0- 10 = 0 to 10V. U 10-0 = 10 to 0V, A 0-20 = 0 to 20mA A 20-0 = 20 to 0mA A 4-20 = 4 to 20mA A 20-4 = 20 to 4mA	See Below		U 0- 10	-
P2-13	Analog/Digital Output 2 (Terminal 11) Function Select Digital Output Mode. Logic 1 = +24V DC 0: Drive Enabled (Running). Logic 1 when the Optidrive P2 Elevator drive is enabled (Running) 1: Drive Healthy. Logic 1 When no Fault condition exists on the drive ("inH" is not included as a fault) 2: At Target Frequency (Speed). Logic 1 when the output frequency matches the setpoint frequency 3: Output Frequency > 0.0. Logic 1 when the motor runs above zero speed 4: Output Frequency >= Limit. Logic 1 when the motor speed exceeds the adjustable limit 5: Reserved. 6: Rescue Mode Active. Logic 1 when the drive is operating in "Rescue Mode" (Rescue mode is detailed in section 14.2). 7: Analog Input 2 Signal Level >= Limit. Logic when the signal applied to the Analog Input 2 exceeds the adjustable limit Note: When using settings 4 – 7, parameters P2-16 and P2-17 must be used together to control the behaviour. The output will switch to Logic 1 when the selected signal exceeds the value programmed in P2-16, and return to Logic 0 when the signal falls below the value programmed in P2-17. Analog Output Mode 8: Output Frequency (Motor Speed). 0 to P1-02 9: Output (Motor) Current. 0 to 200% of P1-08 10: Motor Torque. 0 to 200% of motor rated torque 11: Output (Motor) Power. 0 to 150% of drive rated power	0	11	0	-

Par	Parameter Name	Minimum	Maximum	Default	Units
P2-14	Analog Output 2 (Terminal 11) Format	See Below	See Below	U 0-10	-
	<p>U 0-10 = 0 to 10V. U 10-0 = 10 to 0V, A 0-20 = 0 to 20mA A 20-0 = 20 to 0mA A 4-20 = 4 to 20mA A 20-4 = 20 to 4mA</p>				
P2-15	User Relay 1 Output (Terminals 14, 15 & 16) Function select	0	8	8	-
	<p>Selects the function assigned to Relay Output 1. The relay has three output terminals, Logic 1 indicates the relay is active, and therefore terminals 14 and 15 will be linked together.</p> <p>0: Drive Enabled (Running). Logic 1 when the motor is enabled 1: Drive Healthy. Logic 1 when power is applied to the drive and no fault exists. ("inH" is not included as a fault) 2: At Target Frequency (Speed). Logic 1 when the output frequency matches the setpoint frequency 3: Output Frequency > 0.0 Hz. Logic 1 when the drive output frequency to the motor is exceeds 0.0Hz 4: Output Frequency >= Limit. Logic 1 when the motor speed exceeds the adjustable limit 5: Output Current >= Limit. Logic 1 when the motor current exceeds the adjustable limit 6: Output Torque >= Limit. Logic 1 when the motor torque exceeds the adjustable limit 7: Analog Input 2 Signal Level >= Limit. 1 Logic when the signal applied to the Analog Input 2 exceeds the adjustable limit Note: When using settings 4 – 7, parameters P2-16 and P2-17 must be used together to control the behaviour. The output will switch to Logic 1 when the selected signal exceeds the value programmed in P2-16, and return to Logic 0 when the signal falls below the value programmed in P2-17. 8: Motor Contactor Control. Used to control the operation of a contactor installed on the output side of the drive between the drive and motor. (see section 6.11 for more details)</p>				
P2-16	Adjustable Threshold 1 Upper Limit (Analog Output 1 / Relay Output 1)	P2-17	200.0	100.0	%
P2-17	Adjustable Threshold 1 Lower Limit (Analog Output 1 / Relay Output 1)	0.0	P2-16	0.0	%
	Used in conjunction with some settings of Parameters P2-11 & P2-15.				
P2-21	Display Scaling Factor	-30.000	30.000	0.000	-
P2-22	Display Scaling Source	0	3	0	-
	<p>P2-21 & P2-22 allow the user to program the Optidrive P2 Elevator drive to display an alternative output unit scaled from an existing parameter, e.g. to display conveyer speed in metres per second based on the output frequency. This function is disabled if P2-21 is set to 0.</p> <p>If P2-21 is set >0, the variable selected in P2-22 is multiplied by the factor entered in P2-21, and displayed whilst the drive is running, with a 'c' to indicate the customer scaled units.</p> <p>P2-22 Options 0 : Motor Speed 1 : Motor Current 2 : Analog Input 2 3: P0-80 (signed with one decimal place)</p>				
P2-24	Effective Switching Frequency	Drive Rating Dependent			kHz
	Effective power stage switching frequency. The range of settings available and factory default parameter setting depend on the drive power and voltage rating. Higher frequencies reduce the audible 'ringing' noise from the motor, and improve the output current waveform, at the expense of increased drive losses.				
P2-25	2nd Deceleration Ramp Time	0.00	240	0.00	Seconds
	This parameter allows an alternative deceleration ramp down time to be programmed into the Optidrive P2 Elevator drive, which can be selected by digital inputs (dependent on the setting of P1-13). When set to 0.0, the drive will coast to stop.				
P2-30	Analog Input 1 (Terminal 6) Format	See Below		U 0-10	-
	<p>U 0-10 = 0 to 10 Volt Signal (Uni-polar) U 10-0 = 10 to 0 Volt Signal (Uni-polar) - 10-10 = -10 to +10 Volt Signal (Bi-polar) A 0-20 = 0 to 20mA Signal t 4-20 = 4 to 20mA Signal, the Optidrive P2 Elevator drive will trip and show the fault code 4-20F if the signal level falls below 3mA r 4-20 = 4 to 20mA Signal, the Optidrive P2 Elevator drive will ramp to stop if the signal level falls below 3mA t 20-4 = 20 to 4mA Signal, the Optidrive P2 Elevator drive will trip and show the fault code 4-20F if the signal level falls below 3mA r 20-4 = 20 to 4mA Signal, the Optidrive P2 Elevator drive will ramp to stop if the signal level falls below 3mA</p>				

Par	Parameter Name	Minimum	Maximum	Default	Units
P2-31	Analog Input 1 Scaling	0.0	500.0	100.0	%
	Scales the analog input by this factor, e.g. if P2-30 is set for 0 – 10V, and the scaling factor is set to 200.0%, a 5 volt input will result in the drive running at maximum speed (P1-01)				
P2-32	Analog Input 1 Offset	-500.0	500.0	0.0	%
	Sets an offset, as a percentage of the full scale range of the input, which is applied to the analog input signal				
P2-33	Analog Input 2 (Terminal 10) Format	See Below		U 0-10	-
	U 0-10 = 0 to 10 Volt Signal (Uni-polar)				
	U 10-0 = 10 to 0 Volt Signal (Uni-polar)				
	Ptc-th = Motor PTC Thermistor Input				
	R 0-20 = 0 to 20mA Signal				
	t 4-20 = 4 to 20mA Signal, the Optidrive P2 Elevator drive will trip and show the fault code 4-20F if the signal level falls below 3mA				
	r 4-20 = 4 to 20mA Signal, the Optidrive P2 Elevator drive will ramp to stop if the signal level falls below 3mA				
	t 20-4 = 20 to 4mA Signal, the Optidrive P2 Elevator drive will trip and show the fault code 4-20F if the signal level falls below 3mA				
P2-34	Analog Input 2 Scaling	0.0	500.0	100.0	%
	Scales the analog input by this factor, e.g. if P2-30 is set for 0 – 10V, and the scaling factor is set to 200.0%, a 5 volt input will result in the drive running at maximum speed (P1-01)				
P2-35	Analog Input 2 Offset	-500.0	500.0	0.0	%
	Sets an offset, as a percentage of the full scale range of the input, which is applied to the analog input signal				
P2-36	Start Mode Select / Automatic Restart	See Below		Ed9E-r	-
	Defines the behaviour of the drive relating to the enable digital input and also configures the Automatic Restart function.				
	Ed9E-r : Following Power on or reset, the drive will not start if Digital Input 1 remains closed. The Input must be closed after a power on or reset to start the drive.				
	AUto-0 : Following a Power On or Reset, the drive will automatically start if Digital Input 1 is closed.				
	AUto-1 to AUto-5 : Following a trip, the drive will make up to 5 attempts to restart at 20 second intervals. The drive must be powered down to reset the counter. The numbers of restart attempts are counted, and if the drive fails to start on the final attempt, the drive will fault with, and will require the user to manually reset the fault. Note: The reset time (default 20 sec's) can be modified using parameter P6-03 (1s..60s)				
P2-37	Keypad Mode Restart Speed	0	7	1	-
	This parameter is only active when P1-12 = 1 or 2. When settings 0 to 3 are used, the drive must be started by pressing the Start key on the keypad. When settings 4 – 7 are used, the drive starting is controlled by the enable digital input.				
	0: Minimum Speed. Following a stop and restart, the drive will always initially run at the minimum speed P1-02				
	1: Previous Operating Speed. Following a stop and restart, the drive will return to the last keypad setpoint speed used prior to stopping				
	2: Current Running Speed. Where the Optidrive P2 Elevator drive is configured for multiple speed references (typically Hand / Auto control or Local / Remote control), when switched to keypad mode by a digital input, the drive will continue to operate at the last operating speed				
	3: Inspection Speed. Following a stop and restart, the Optidrive P2 Elevator drive will always initially run at Inspection Speed(P2-04)				
	4: Minimum Speed (Terminal Enable). Following a stop and restart, the drive will always initially run at the minimum speed P1-02				
	5: Previous Operating Speed (Terminal Enable). Following a stop and restart, the drive will return to the last keypad setpoint speed used prior to stopping				
6: Current Running Speed (Terminal Enable). Where the Optidrive P2 Elevator drive is configured for multiple speed references (typically Hand / Auto control or Local / Remote control), when switched to keypad mode by a digital input, the drive will continue to operate at the last operating speed					
7: Inspection Speed. (Terminal Enable). Following a stop and restart, the Optidrive P2 Elevator drive will always initially run at Inspection Speed(P2-04)					
P2-39	Parameter Access Lock	0	1	0	-
	0: Unlocked. All parameters can be accessed and changed 1: Locked. Parameter values can be displayed, but cannot be changed				
P2-40	Extended Parameter Access Code Definition	0	9999	101	-
	Defines the access code which must be entered in P1-14 to access parameter groups above Group 1				

16.4. Parameter Group 3 – S-ramps, Output contactor/Brake, Short floor, Light load detection.

Par	Parameter Name	Minimum	Maximum	Default	Units
P3-01	Acceleration Start Jerk	0.0	5.0	1.0	s
P3-02	Acceleration end Jerk	0.0	5.0	1.0	s
P3-03	Deceleration Start Jerk	0.0	5.0	1.0	s
P3-04	Deceleration end Jerk	0.0	5.0	1.0	s
P3-05	Stopping Jerk	0.0	5.0	1.0	s
	S- Ramps are used to smooth the starting and stopping behaviour of the drive, refer to the diagram in section 13.1 for further information on the operation of the S-Ramps.				
P3-06	Output Contactor Closing Time/Run command delay time	0.00	5.0	0.2	s
	Sets a delay time between the enable signal being applied to the Optidrive P2 Elevator drive and energising of the motor. This prevents over current trips which may be caused when a contactor is installed between the Optidrive P2 Elevator drive and the motor. The contactor can optionally be controlled by the drive using Output Relay 1.				
P3-07	Brake Release time	0.0	2.00	0.50	s
	Sets the delay time, following the contactor Delay time (P3-06) in which the motor brake will be released (Relay 2) and the drive output frequency ramps up.				
P3-08	Brake Apply Delay	0.00	2.00	0.20	s
	Sets the delay time allowed for the motor brake to apply when stopping. (Motor brake control method 2 in section 6.12.2				
P3-09	Brake Apply Speed	0.0	P1-01	0.0	Hz
	Sets the speed at which the drive will signal the motor brake to apply. This speed must not be greater than the levelling & maintenance speeds.				
P3-10	Zero Speed Holding Time on disable	0.0	60.0	0.2	s
	Sets the time for which the drive will hold the motor at zero speed prior to the output being disabled to allow the motor brake to engage.				
P3-11	Short Floor Operation	0	1	0	-
	0 : Disabled 1: Enabled.				
	See section 14.1 Short Floor Operation for more detail				
P3-12	Rescue Operation Function	0	3	0	-
	0 : Basic Rescue mode 1 : Light Load Detection 2 : Reserved-Do not use 3 : UPS Easiest direction based on Load measurement				
	See section 14.2				
	Rescue Mode Operation (UPS Power Supply) for more details				
P3-13	Brake Resistor Resistance	25.0	Drive Rating Dependant	Drive Rating Dependant	Ω
P3-14	Brake Resistor Power	0.0	200.00	0.00	kW
	For software protection of the connected brake resistor, enter the rated power and resistance of the resistor into the relevant parameters. The drive will then monitor the brake resistor to ensure that it does not operate outside of its designed limits. Where an external thermal protection device is fitted, and software protection is not required. Setting parameter P3-14 to zero will disable the software protection feature.				
P3-15	Sheave diameter	0.0	2000.0	0.0	-
	If value entered is <100 drive assumes inches, if >100 drive assumes mm				
P3-16	Roping Ratio	1	4	1	-
	1 : 1:1 2 : 2:1 3 : 3:1 4 : 4:1				
P3-17	Gear Ratio	1.0	100.0	1.0	-
	P3-15, P3-16 and P3-17 are used internally by the drive to provide elevator speed in user units as per section 9.7				
Note: P1-10 must also be programmed for elevator speed in user units to operate.					
P3-18	Motor Connected Check	0.0	100.00	15	%
	At each start, the drive injects a current pulse of this magnitude (% of motor rated current) to confirm that the motor is connected. The default value rarely requires adjustment, the drive will trip "OUT-Ph" or "OUT-F" (Size 2) if the drive detects the motor is not connected. See section 14.3 for more details.				
P3-19	Torque Reduction during stopping	0.0	100	10.0	%
	This parameter helps in reducing the noise in the lift car when the motor brake is closed due to the removal of current. Increasing this value reduces audible noise, setting too high can result in reduced torque and rollback during stopping.				

16.5. Parameter Group 4 –Motor Control modes, Speed Loop Gains, Current limits.

Par	Parameter Name	Minimum	Maximum	Default	Units
	 Incorrect adjustment of parameters in menu group 4 can cause unexpected behaviour of the motor and any connected machinery. It is recommended that these parameters are only adjusted by experienced users.				
P4-01	Motor Control Mode Selects the motor control method. An auto-tune must be performed if setting 0 or 1 or 3 is used. 0: Advanced Vector IM Speed Control 1: Vector IM Speed Control 2: Enhanced V/F IM Speed Control 3 : PM Motor Speed Control	0	3	0	-
P4-02	Motor Parameter Auto-tune Enable 1. When set to 1, (All Motors) the drive immediately carries out a non-rotating auto-tune to measure the motor parameters for optimum control and efficiency. Following completion of the auto-tune, the parameter automatically returns to 0. 2. When set to 2, (PM Motors only), the drive carries out a stationary Encoder offset measurement (see section 12.7) and populates P6-09 with the result. Following completion, the parameter automatically returns to 0.	0	2	0	-
P4-03	Vector Speed Controller Proportional Gain Sets the proportional gain value for the speed controller. Higher values provide better output frequency regulation and response. Too high a value can cause instability, Vibration or even over current trips. For applications requiring best possible performance, the value should be adjusted to suit the connected load. (Not active when P4-01=2, Enhanced V/F mode)	0.1	400	50.0	%
P4-04	Vector Speed Controller Integral Time Constant Sets the integral time for the speed controller. Smaller values provide a faster response in reaction to motor load changes, at the risk of introducing instability. For best dynamic performance, the value should be adjusted to suit the connected load. (Not active when P4-01=2, Enhanced V/F mode)	0.001	1.000	0.050	s
P4-05	Motor Power Factor Cos ϕ When operating in Vector Speed motor control modes (P4-01 = 0,1,3),this parameter must be set to the motor nameplate power factor	0.00	0.99	-	-
P4-07	Maximum Motoring Torque Limit When operating in Vector Speed motor control modes (P4-01 = 0, 1, 3), this parameter defines the maximum torque limit.	0.0	500.0	200.0	%
P4-09	Generator Mode Max. Torque Limit (Maximum Regenerative Torque) Active only in Vector Speed motor control modes (P4-01 = 0 or 1). Sets the maximum regenerating torque allowed by the Optidrive P2 Elevator drive.	0.0	500.0	150.0	%
P4-10	V/F Characteristic Adjustment Frequency When operating in V/F mode (P4-01 = 2), this parameter in conjunction with P4-11 sets a frequency point (as a % of P1-09) at which the voltage set in P4-11 (as a % of P1-07) is applied to the motor. Care must be taken to avoid overheating and damaging the motor when using this feature.	0.0	100.00	0.0	%
P4-11	V/F Characteristic Adjustment Voltage Used in conjunction with parameter P4-10	0	100.00	0.0	%
P4-12	Thermal Overload Value Retention 0: Disabled. 1: Enabled. All Optidrive P2 drives feature electronic thermal overload protection for the connected motor, designed to protect the motor against damage. An internal overload accumulator monitors the motor output current over time, and will trip the drive if the usage exceeds the thermal limit. When P4-12 is disabled, removing the power supply from the drive and re-applying will reset the value of the accumulator. When P4-12 is enabled, the value is retained during power off.	0	1	0	-
P4-13	Output Phase Sequence (Geared /Induction motor systems only) 0 : U,V, W. 1 : U, W, V. Direction of motor rotation when operating in a forward direction will be reversed.	0	1	0	-
P4-14	Reserved	-	-	-	-
P4-15	Low Speed Proportional Gain Sets the proportional gain value for the speed controller during low speed operation, low speed operation is defined as a speed value less than the value set in P4-17 (Low speed Gains transition point) This parameter is only active if P4-17 (Low speed Gains transition point) is >0. (Not active when P4-01=2, Enhanced V/F mode)	0.01	400	50.0	-
P4-16	Low Speed Integral Gain Sets the Integral gain value for the speed controller during low speed operation, low speed operation is defined as a speed value less than the value set in P4-17 (Low speed Gains transition point) This parameter is only active if P4-17 (Low speed Gains transition point) is >0. (Not active when P4-01=2, Enhanced V/F mode)	0.001	1.000	0.05	s
P4-17	Low Speed Gains Transition Point The Low speed Gains (P4-15 & P4-16) are active up until the value set in this parameter. Set in rpm if P1-10 Motor rated speed has been entered otherwise value is in Hz. (Not active when P4-01=2, Enhanced V/F mode)	0	250	0.0	Hz / Rpm

16.6. Parameter Group 5 – Modbus, CAN Open Communication.

Par	Parameter Name	Minimum	Maximum	Default	Units
P5-01	Drive Fieldbus Address	0	63	1	-
	Sets the fieldbus address for the Optidrive P2 Elevator drive				
P5-02	CAN Open Baud Rate	125	1000	500	kbps
	Sets the baud rate when CAN Open communications are used				
P5-03	Modbus RTU Baud Rate	9.6	115.2	115.2	kbps
	Sets the baud rate when CAN Open communications are used				
P5-04	Modbus Data Format	-	-	n-1	-
	Sets the expected Modbus telegram data format as follows n-1 : No Parity, 1 stop bit n-2 : No parity, 2 stop bits O-1 : Odd parity, 1 stop bit E-1 : Even parity, 1 stop bit				
P5-05	Communications Loss Timeout	0.0	5.0	1.0	s
	Sets the watchdog time period for the communications channel. If a valid telegram is not received by the Optidrive P2 Elevator drive within this time period, the drive will assume a loss of communications has occurred and react as selected below				
P5-06	Communications Loss Action	0	3	0	-
	Controls the behaviour of the drive following a loss of communications as determined by the above parameter setting. 0 : Trip 1 : Ramp to Stop Then Trip 2 : Ramp to Stop Only (No Trip) 3 : Run at Inspection Speed (P2-04)				
P5-07	Fieldbus Ramp Control	0	1	0	-
	Selects whether the acceleration and deceleration ramps are control directly via the Fieldbus, or by internal drive parameters P1-03 and P1-04. 0 : Disabled. Ramps are control from internal drive parameters 1 : Enabled. Ramps are controlled directly by the Fieldbus				
P5-08	Fieldbus Process Data Word 4 Output Select	0	7	0	-
	When using an optional fieldbus interface, this parameter configures the parameter source for the 4 th process data word transferred from the drive to the network master during cyclic communications 0 : Output Torque – 0 to 2000 = 0 to 200.0% 1 : Output Power – Output power in kW to two decimal places, e.g. 400 = 4.00kW 2 : Digital Input Status – Bit 0 indicates digital input 1 status, bit 1 indicates digital input 2 status etc. 3 : Analog Input 2 Signal Level – 0 to 1000 = 0 to 100.0% 4 : Drive Heatsink Temperature – 0 to 100 = 0 to 100°C 5 : User register 1 6 : User register 2 7 : P0-80 Value				
P5-12	Fieldbus Process Data Word 3 Output Select	0	7	0	-
	When using an optional fieldbus interface, this parameter configures the parameter source for the 3 rd process data word transferred from the drive to the network master during cyclic communications 0 : Output Torque – 0 to 2000 = 0 to 200.0% 1 : Output Power – Output power in kW to two decimal places, e.g. 400 = 4.00kW 2 : Digital Input Status – Bit 0 indicates digital input 1 status, bit 1 indicates digital input 2 status etc. 3 : Analog Input 2 Signal Level – 0 to 1000 = 0 to 100.0% 4 : Drive Heatsink Temperature – 0 to 100 = 0 to 100°C 5 : User register 1 6 : User register 2 7 : P0-80 Value				
P5-13	Fieldbus Process Data Word 4 Output Select	0	1	0	-
	When using an optional fieldbus interface, this parameter configures the parameter source for the 4 th process data word transferred from the drive to the network master during cyclic communications 0 : Output Torque – 0 to 2000 = 0 to 200.0% 1 : Output Power – Output power in kW to two decimal places, e.g. 400 = 4.00kW				
P5-14	Fieldbus Process Data Word 3 Output Select	0	2	0	-
	When using an optional fieldbus interface, this parameter configures the parameter source for the 3 rd process data word transferred from the drive to the network master during cyclic communications 0 : Output Torque – 0 to 2000 = 0 to 200.0% 1 : Output Power – Output power in kW to two decimal places, e.g. 400 = 4.00kW 2 : Digital Input Status – Bit 0 indicates digital input 1 status, bit 1 indicates digital input 2 status etc.				

16.7. Parameter Group 6: Encoder setup, Brake Release Monitoring,

Par	Parameter Name	Minimum	Maximum	Default	Units
P6-01	Firmware Upgrade Enable	0	3	0	-
	Internal use only. Only to be changed with guidance from technical support.				
P6-02	Auto thermal management	4kHz	12kHz	4kHz	kHz
	This parameter defines the minimum effective switching frequency which the drive will use when the drive auto- switches down the switching frequency in order to reduce the losses and heat from the power stage.				
P6-03	Auto-reset delay time	1	60	20	s
	Sets the delay time which will elapse between consecutive drive reset attempts when Auto Reset is enabled in P2-36				
P6-04	User relay hysteresis band	0.0	25.0	0.3	%
	This parameter works in conjunction with P2-11 and P2-13 = 2 or 3 to set a band around the target speed (P2-11 = 2) or zero speed (P2-11 = 3). When the speed is within this band, the drive is considered to be at target speed or Zero speed. This function is used to prevent "chatter" on the relay output if the operating speed coincides with the level at which the digital / relay output changes state. e.g. if P2-13 = 3, P1-01 = 50Hz and P6-04 = 5%, the relay contacts close above 2.5Hz				
P6-05	Encoder feedback enable	0	1	0	-
	Setting to 1 enables encoder control mode of operation (Closed loop). For correct operation, ensure that the encoder has been properly fitted to the motor and its wiring is connected to the encoder feedback module in accordance with the manual. Before enabling this parameter, for Geared (Induction) motors run the drive in open loop mode (P6-05=0) and ensure that the sense of rotation is correct by using parameter P0-58 (encoder feedback speed). The sign in P0-58 should match that of the speed reference.				
P6-06	Encoder PPR	0	65535	0	-
	Sets the number of Pulses Per Revolution for the encoder. This value has to be set correctly to guarantee proper operation of the drive when Encoder feedback mode is enabled (P6-05 = 1). Improper setting of this parameter could cause the loss of control of the drive and / or a trip. If set to zero, encoder feedback will be disabled. Typically values for Incremental encoders are 512, 1024, 2048, 4096, for Endat, SinCos Encoders 65535 must be entered.				
P6-07	Speed error trip level	0.0	100.0	10.0	%
	This parameter defines the maximum permissible speed error between the encoder feedback speed value and the estimated rotor speed calculated by the motor control algorithms. If the speed error exceeds this limit, the drive will trip <i>SP_Err</i> . When set to zero, this protection is disabled.				
P6-08	Max speed ref frequency	0.0	20	0	kHz
	0 (Disabled), 5kHz to 20kHz				
P6-09	Encoder offset	0.0	360.0	0.0	°
	PM Motors only : 0.0 ...360.0° as measured by the stationary encoder offset measurement (P4-02=2)				
P6-10	Enable PLC operation	0	1	0	-
	0: Disable 1: Enable				
P6-11	Brake Release-monitoring terminal Enable	Off	t18t19	Off	-
	OFF: Brake release monitoring Disabled. din-1...din-5 t18t19: T18 & T19 of Encoder module (OPT-2-ENDAT2-IN/ OPT-2-SINCOS2-IN) used for monitoring brake micro switches.				
P6-12	Brake Release- monitoring time	0.1	5.0	0.5	s
	If the monitoring terminal has not changed state in this time then the drive will trip " <i>bF-Err</i> " or " <i>bF-Loc</i> " (if number of attempts as set in P6-13 has been met) See section 14.4.				
P6-13	Brake Release-number of errors before lockout	0	5	0	-
	Number of brake release monitoring errors before permanent trip " <i>bF-Loc</i> " is displayed. If Parameter P2-36 is set to ' <i>Auto-D</i> ' then the drive will automatically reset the " <i>bF-Err</i> " message, otherwise the trip will have to be reset manually e.g. Enable/direction input toggled.				
P6-17	Max Torque limit timeout	0.0	25.0	0.0	s
	Sets the maximum time allowed for the motor to be operating at the motor/generator torque limit (P4-07/P4-09) before tripping. This parameter is enabled only for vector control operation.				
P6-18	DC injection braking voltage	0.0	30.0	0.0	%
	Auto, 0.0..25.0% (V/F mode only)				
P6-22	Reset cooling fan run-time	0	1	0	-
	Setting to 1 resets internal Fan run-time counter to zero (as displayed in P0-35).				
P6-23	Reset kWh meter	0	1	0	-
	Setting to 1 resets internal kWh meter to zero (as displayed in P0-26 and P0-27).				
P6-24	Service time interval	0	60000	0	h
	Defines the service interval counter period. This defines the total number of run time hours which must elapse before the service indicator is shown on the drive (OLED/Optipad) display. When P6-25 is set to 1, the internal service interval counter is set to this value.				
P6-25	Reset service indicator	0	1	0	-
	When this parameter is set to 1, the internal service interval counter is set to the value defined in P6-24				
P6-26	Analog output 1 scaling	0	500.0	100.0	%
	Defines the scaling factor as a percentage used for Analog Output 1 Output value = (Input value - Offset) * Scaling				

Par	Parameter Name	Minimum	Maximum	Default	Units
P6-27	Analog output 1 offset	-500.0	500.0	0.0	%
	Defines the offset as a percentage used for Analog Output 1 Output value = (Input value - Offset) * Scaling				
P6-28	P0-80 display value index	0	-	0	-
	Internal use only. Only to be changed with guidance from technical support.				
P6-29	Save User Parameters as default	0	2	0	-
	Setting this parameter to 1 saves the current parameter settings as "User default parameters". When the User carries out a 3-button default parameter command (UP, DOWN and STOP), the parameters saved when P6-29 was last set to 1 will be restored, Setting "2" clears user parameters.				
P6-30	Level 3 access code	0	9999	201	-
	Defines the access code which must be entered into P1-14 to allow access to the Advanced Parameters in Groups 6 to 9.				

16.8. Parameter Group 7: Motor measured data, Rollback control gains.

Par	Parameter Name	Minimum	Maximum	Default	Units
P7-01	Motor Stator Resistance (Rs)	0.000	31.500	Rating dependant	Ohm
	For Geared (Induction) and PM motors: phase to phase rotor resistance value in ohms as measured following an Auto-tune.				
P7-02	Motor Rotor resistance (Rr)	0.000	31.500	Rating dependant	Ohm
	For Geared (Induction) motors: phase to phase rotor resistance value in ohms as measured following an Auto-tune.				
P7-03	Motor stator inductance (Lsd)	0.0000	1.0000	Rating dependant	H
	For Geared (Induction) motors: phase stator inductance value. For Gearless (Permanent Magnet) motors: phase d-axis stator inductance in Henry (H).				
P7-04	Motor Magnetising current (Id rms)	0.0	Rating dependant	Rating dependant	A
	For Geared (Induction) motors only: magnetizing / no load current, before Auto-tune, this value is approximated to 60% of motor rated current (P1-08), assuming a motor power factor of 0.8. Note: For gearless PM motors this value must be 0.				
P7-05	Motor Leakage coefficient (sigma)	0.000	0.250	Rating dependant	
	For Geared (Induction) motors: motor leakage inductance coefficient				
P7-06	Motor stator inductance (Lsq) – PM motors only	0.0000	1.0000	Rating dependant	H
	For PM motors: phase d-axis stator inductance in Henry (H).				
P7-07	Enhanced generator control	-	-	-	-
	Internal use only. Only to be changed with guidance from Invertek technical support.				
P7-08	Motor Auto-Pre torque	0	1	0	-
	Provides a pre-torque value (prior to brake release), normally used to improve Gearless motor rollback if P7-13 limit has been reached, and also helps reduce noise as a result of rollback function. Also Active in Rescue mode.				
P7-09	Over voltage current limit	-	-	-	-
	Internal use only. Only to be changed with guidance from Invertek technical support.				
P7-10	System Inertia constant	0	600	10	
	System Load Inertia to Motor Inertia Ratio entered as H = (JTot/JMot) this value can normally be left at the default value (10).				
P7-11	Pulse width minimum limit	-	-	-	-
	Internal use only. Only to be changed with guidance from Invertek technical support.				
P7-12	V/F mode/PM magnetising period	-	-	-	-
	Internal use only. Only to be changed with guidance from Invertek technical support.				
P7-13	Rollback Control Gain	0.0	400.0	0.0	%
	Sets the Rollback gain value (Active during P3-07 brake release time). Increase to solve rollback, too high a value can cause instability/Vibrations/Over current trips, See section 13.3 for full details. Also Active in Rescue mode.				
P7-14	Low frequency torque boost	0.0	100	0.0	
	Not used when P4-01 = 2, Primarily intended for PM Motors operating in open loop. Allows a Boost current to be applied at start-up and low frequency (limit defined by P7-15), as a % of the motor rated current (P1-08). Injecting some additional current into the motor at low speed to ensure that rotor alignment is maintained, and improving operation during starting and low speed.				
P7-15	Torque boost frequency limit	0.0	50.0	0.0	Hz
	Frequency range for applied boost current (P7-14) as a % of motor rated frequency (P1-09). This sets the frequency cut-off point above which boost current is no longer applied to the motor.				
P7-16	Reserved – Do not use	-	-	-	-
P7-17	Rescue Mode P-gain	0	400	10	-
	Sets the proportional gain value for the speed controller during rescue Mode operation. Too high a value can cause instability or even over current trips.				

16.9. Group 8 and Group 9: Refer to Optitools studio commissioning tool.**16.10. Parameter Group 0 – Monitoring Parameters (Read Only)**

Par	Description	Units
P0-01	Analog Input 1 Applied Signal Level	%
	Displays the signal level applied to analog input 1 (Terminal 6) after scaling and offsets have been applied.	
P0-02	Analog Input 2 Applied Signal Level	%
	Displays the signal level applied to analog input 2 (Terminal 10) after scaling and offsets have been applied.	
P0-03	Digital Input Status	-
	Displays the status of the drive inputs, starting with the left hand side digit = Digital Input 1 etc.	
P0-04	Pre Ramp Speed Controller Reference	Hz
	Displays the set point reference input applied to the drive internal speed controller	
P0-05	Torque Controller Reference	%
	Displays the set point reference input applied to the drive internal torque controller	
P0-06	Digital Speed Reference (Motorised Pot)	Hz
	Displays the value of the drive internal Motorised Pot (used for keypad) speed reference	
P0-07	Fieldbus Communication Speed Reference	Hz
	Displays the setpoint being received by the drive from the currently active Fieldbus interface.	
P0-08	PID Reference (Setpoint)	%
	Displays the setpoint input to the PID controller.	
P0-09	PID Feedback Level	%
	Displays the Feedback input signal to the PID controller	
P0-10	PID Controller Output	%
	Displays the output level of the PID controller	
P0-11	Applied Motor Voltage	V
	Displays the instantaneous output voltage from the drive to the motor	
P0-12	Output Torque	%
	Displays the instantaneous output torque level produced by the motor	
P0-13	Trip History Log	-
	Displays the last four fault codes for the drive. Refer to section 19.1 for further information	
P0-14	Motor Magnetising Current (Id)	A
	Displays the motor magnetising Current, providing an auto tune has been successfully completed.	
P0-15	Motor Rotor Current (Iq)	A
	Displays the motor Rotor (torque producing) current, providing an auto tune has been successfully completed.	
P0-16	DC Bus Voltage Ripple Level	V
	Displays the level of ripple present on the DC Bus Voltage. This parameter is used by the Optidrive P2 Elevator drive for various internal protection and monitoring functions.	
P0-17	Motor Stator resistance (Rs)	Ω
	Displays the measured motor stator resistance, providing an auto tune has been successfully completed.	
P0-18	Motor Stator Inductance (Ls)	H
	Displays the measured motor stator inductance, providing an auto tune has been successfully completed.	
P0-19	Motor Rotor Resistance (Rr)	Ohms
	Displays the measured motor rotor resistance, providing an auto tune has been successfully completed.	
P0-20	DC Bus Voltage	V
	Displays the instantaneous DC Bus Voltage internally within the drive	
P0-21	Drive Temperature	°C
	Displays the Instantaneous Heatsink Temperature measured by the drive	
P0-22	Time Remaining to next service	V
	Displays the number of hours remaining on the service time counter before the next service is due.	
P0-23	Operating Time Accumulated With Heatsink Temperature Above 85°C	HH:MM:SS
	Displays the amount of time in hours and minutes that the Optidrive P2 Elevator drive has operated for during its lifetime with a heatsink temperature in excess of 80°C. This parameter is used by the Optidrive P2 Elevator drive for various internal protection and monitoring functions.	
P0-24	Operating Time Accumulated With Ambient Temperature Above 80°C	HH:MM:SS
	Displays the amount of time in hours and minutes that the Optidrive P2 Elevator drive has operated for during its lifetime with an ambient temperature in excess of 80°C. This parameter is used by the Optidrive P2 Elevator drive for various internal protection and monitoring functions.	
P0-25	Rotor Speed (Estimated or Measured)	-
	In Vector control mode, this parameter displays either the estimated rotor speed of the motor, if no encoder feedback is present, or the measured rotor speed if an optional Encoder Feedback Interface Option is fitted.	

Par	Description	Units
P0-26	Energy Consumption kWh Meter	kWh
	Displays the amount of energy consumed by the drive in kWh. When the value reaches 1000, it is reset back to 0.0, and the value of P0-27 (*MWh meter) is increased.	
P0-27	Energy Consumption MWh Meter	MWh
	Displays the amount of energy consumed by the drive in MWh.	
P0-28	Software Version and Checksum	-
	Displays the software version of the drive	
P0-29	Drive Type	-
	Displays the type details of the drive	
P0-30	Drive Serial Number	-
	Displays the unique serial number of the drive.	
P0-31	Drive Lifetime Operating Time	HH:MM:SS
	Displays the total operating time of the drive. The first value shown is the number of hours. Pressing the Up key will display the minutes and seconds.	
P0-32	Drive Run Time Since Last Trip (1)	HH:MM:SS
	Displays the total operating time of the drive since the last fault occurred. The first value shown is the number of hours. Pressing the Up key will display the minutes and seconds.	
P0-33	Drive Run time Since Last Trip (2)	HH:MM:SS
	Displays the total operating time of the drive since the last fault occurred. The first value shown is the number of hours. Pressing the Up key will display the minutes and seconds.	
P0-34	Drive Run Time Since Last Disable	HH:MM:SS
	Displays the total operating time of the drive since the last Run command was received. The first value shown is the number of hours. Pressing the Up key will display the minutes and seconds.	
P0-35	Drive Internal Cooling Fan Total Operating Time	HH:MM:SS
	Displays the total operating time of the Optidrive P2 Elevator drive internal cooling fans. The first value shown is the number of hours. Pressing the Up key will display the minutes and seconds. This is used for scheduled maintenance information	
P0-36	DC Bus Voltage Log (256ms)	V
P0-37	DC Bus Voltage Ripple Log (20ms)	V
P0-38	Heatsink Temperature Log (30s)	°C
P0-39	Ambient Temperature Log (30s)	°C
P0-40	Motor Current Log (256ms)	A
	The above parameters are used to store the history of various measured levels within the drive at various regular time intervals prior to a trip. The values are frozen when a fault occurs and can be used for diagnostic purposes – see section 19.1 for further information	
P0-41	Critical Fault Counter – Over Current	-
P0-42	Critical fault counter – Over Voltage	-
P0-43	Critical fault counter – Under Voltage	-
P0-44	Critical fault counter – Over Temperature	-
P0-45	Critical fault counter – Brake Transistor Over Current	-
P0-46	Critical fault counter – Ambient Over Temperature	-
	These parameters contain a record of how many times certain critical faults have occurred during a drives operating lifetime. This provides useful diagnostic data	
P0-47	Reserved	
	Reserved Parameter	
P0-48	Reserved	
	Reserved Parameter	
P0-49	Modbus RTU Communication Error Counter	-
	This parameter is incremented every time an error occurs on the Modbus RTU communication link. This information can be used for diagnostic purposes.	
P0-50	CAN Open Communication Error Counter	-
	This parameter is incremented every time an error occurs on the CAN Open communication link. This information can be used for diagnostic purposes.	

17. Serial communications

17.1. RS-485 communications

Optidrive P2 Elevator drive has an RJ45 connector on the front of the control panel. This connector allows the user to set up a drive network via a wired connection. The connector contains two independent RS485 connections, one for Invertek’s Optibus Protocol and one for Modbus RTU. Both connections can be used simultaneously.

The electrical signal arrangement of the RJ45 connector is shown as follows:

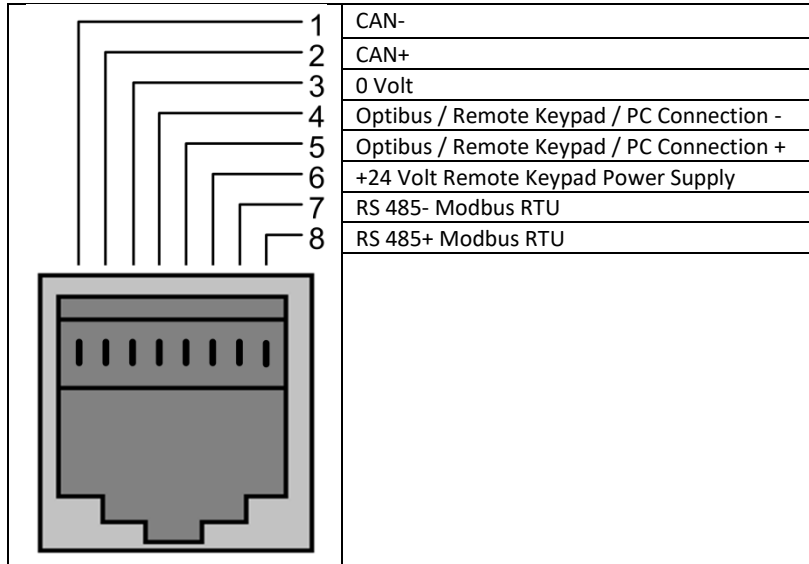

17.2. Modbus RTU Communications

17.2.1. Modbus Telegram Structure

The Optidrive P2 Elevator drive supports Master / Slave Modbus RTU communications, using the 03 Read Holding Registers and 06 Write Single Holding Register commands. Many Master devices treat the first Register address as Register 0; therefore it may be necessary to convert the Register Numbers detailed in section 17.2.2 & 17.2.3 by subtracting 1 to obtain the correct Register address. The telegram structure is as follows:-

Command 03 – Read Holding Registers					
Master Telegram			Slave Response		
	Length			Length	
Slave Address	1	Byte	Slave Address	1	Byte
Function Code (03)	1	Byte	Starting Address	1	Byte
1 st Register Address	2	Bytes	1 st Register Value	2	Bytes
No. Of Registers	2	Bytes	2 nd Register Value	2	Bytes
CRC Checksum	2	Bytes	Etc...		
			CRC Checksum	2	Bytes

Command 06 – Write Single Holding Register					
Master Telegram			Slave Response		
	Length			Length	
Slave Address	1	Byte	Slave Address	1	Byte
Function Code (06)	1	Byte	Function Code (06)	1	Byte
Register Address	2	Bytes	Register Address	2	Bytes
Value	2	Bytes	Register Value	2	Bytes
CRC Checksum	2	Bytes	CRC Checksum	2	Bytes

17.2.2. Modbus Control & Monitoring Registers

The following is a list of accessible Modbus Registers available in the Optidrive P2 Elevator drive.

- When Modbus RTU is configured as the Fieldbus option (P5-01 = 0, factory default setting), all of the listed registers can be accessed.
- Registers 1 and 2 can be used to control the drive providing that Modbus RTU is selected as the primary command source (P1-12 = 4)
- Register 3 can be used to control the output torque level providing that
 - The drive is operating in Vector Speed modes (P4-01 = 0 or 1)
 - The torque controller reference / limit is set for 'Fieldbus' (P4-06 = 3)
- Register 4 can be used to control the acceleration and deceleration rate of the drive providing that Fieldbus Ramp Control is enabled (P5-08 = 1)
- Registers 6 to 24 can be read regardless of the setting of P1-12

Register Number	Upper Byte	Lower Byte	Read Write	Notes
1	Command Control Word		R/W	Command control word used to control the Optidrive P2 Elevator drive when operating with Modbus RTU. The Control Word bit functions are as follows :- Bit 0: Run/Stop command. Set to 1 to enable the drive. Set to 0 to stop the drive. Bit 1: Fast stop request. Set to 1 to enable drive to stop with 2 nd deceleration ramp. Bit 2: Reset request. Set to 1 in order to reset any active faults or trips on the drive. This bit must be reset to zero once the fault has been cleared. Bit 3: Coast stop request. Set to 1 to issue a coast stop command.
2	Command Speed Reference		R/W	Setpoint must be sent to the drive in Hz to one decimal place, e.g. 500 = 50.0Hz
3	Command Torque Reference		R/W	Setpoint must be sent to the drive in % to one decimal place, e.g. 2000 = 200.0%
4	Command Ramp times		R/W	This register specifies the drive acceleration and deceleration ramp times used when Fieldbus Ramp Control is selected (P5-08 = 1) irrespective of the setting of P1-12. The input data range is from 0 to 60000 (0.00s to 600.00s)
6	Error code	Drive status	R	This register contains 2 bytes. The Lower Byte contains an 8 bit drive status word as follows :- Bit 0 : 0 = Drive Disabled (Stopped), 1 = Drive Enabled (Running) Bit 1 : 0 = Drive Healthy, 1 = Drive Tripped The Upper Byte will contain the relevant fault number in the event of a drive trip. Refer to section 19.1 for a list of fault codes and diagnostic information
7	Output Frequency		R	Output frequency of the drive to one decimal place, e.g.123 = 12.3 Hz
8	Output Current		R	Output current of the drive to one decimal place, e.g.105 = 10.5 Amps
9	Output Torque		R	Motor output torque level to one decimal place, e.g. 474 = 47.4 %
10	Output Power		R	Output power of the drive to two decimal places, e.g.1100 = 11.00 kW
11	Digital Input Status		R	Represents the status of the drive inputs where Bit 0 = Digital Input 1 etc.
20	Analog 1 Level		R	Analog Input 1 Applied Signal level in % to one decimal place, e.g. 1000 = 100.0%
21	Analog 2 Level		R	Analog Input 2 Applied Signal level in % to one decimal place, e.g. 1000 = 100.0%
22	Pre Ramp Speed Reference		R	Internal drive frequency setpoint
23	DC bus voltages		R	Measured DC Bus Voltage in Volts
24	Drive temperature		R	Measured Heatsink Temperature in °C

17.2.3. Modbus Parameter Access

All User Adjustable parameters (Groups 1 to 5) are accessible by Modbus, except those that would directly affect the Modbus communications, e.g.

- P5-01 Communication Protocol Select
- P5-02 Drive Fieldbus Address
- P5-03 Modbus RTU Baud Rate
- P5-04 Modbus RTU Data Format

All parameter values can be read from the drive and written to, depending on the operating mode of the drive – some parameters cannot be changed whilst the drive is enabled for example.

When accessing a drive parameter via Modbus, the Register number for the parameter is the same as the parameter number, E.g. Parameter P1-01 = Modbus Register 101.

Modbus RTU supports sixteen bit integer values, hence where a decimal point is used in the drive parameter, the register value will be multiplied by a factor of ten,
E.g. Read Value of P1-01 = 500, therefore this is 50.0Hz.

For further details on communicating with Optidrive P2 Elevator drive using Modbus RTU, please refer to your local Invertek Sales Partner.

18. Technical Data

18.1. Environmental

Ambient temperature range:

Operational	: -10 ... 50°C
Storage and Transportation	: -40 °C ... 60 °C
Max altitude for rated operation	: 1000m (Refer to section 18.5 for Derating Information)
Relative Humidity	: < 95% (non-condensing)

Note : Drive must be Frost and moisture free at all times
Installation above 2000m is not UL approved

18.2. Input voltage ranges

Depending upon model and power rating, the drives are designed for direct connection to the following supplies:

18.2.1. Mains supply.

Model Number	Supply Voltage	Phases	Frequency
ODL-2-x4xxx-3xxxx	380 – 480 Volts + / - 10%	3	50 – 60Hz + / - 5%
ODL-2-x2xxx-3xxxx	200 – 240 Volts + / - 10%	3	50 – 60Hz + / - 5%
ODL-2-x2xxx-1xxxx	200 – 240 Volts + / - 10%	1	50 – 60Hz + / - 5%

18.2.2. Rescue Mode (UPS) supply.

Model Number	Supply Voltage
ODL-2-x4xxx-3xxxx	<ul style="list-style-type: none"> Sine wave Output UPS = 205 -240VAC In order to support Simulated Sine Wave type UPS supplies the DC bus as measured by parameter P0-20 must be in the range 295Vdc - 400Vdc.

All Optidrive P2 Elevator drives have phase imbalance monitoring. A phase imbalance of > 3% will result in the drive tripping. For input supplies which have supply imbalance greater than 3% (typically the Indian sub- continent & parts of Asia Pacific including China) Invertek Drives recommends the installation of input line reactors.

18.3. Output Power and Current ratings

18.3.1. 200 – 240 Volt, 1 Phase Input

Frame Size	Power Rating		Input Current A	Fuse or MCB (Type B)		Maximum Cable Size		Rated Output Current A	Maximum Motor Cable Length		Recommended Brake Resistance (Minimum) Ω
	kW	HP		Non UL	UL	mm	AWG/kcmil		m	ft	
2	0.75	1	8.5	10	15	8	8	4.3	100	330	100 (50)
2	1.5	1.5	15.2	25	20	8	8	7	100	330	50 (32)
2	2.2	1.5	19.5	25	25	8	8	10.5	100	330	35 (25)

18.3.2. 200 – 240 Volt, 3 Phase Input

Frame Size	Power Rating		Input Current A	Fuse or MCB (Type B)		Maximum Cable Size		Rated Output Current A	Maximum Motor Cable Length		Recommended Brake Resistance (Minimum) Ω
	kW	HP		Non UL	UL	mm	AWG/kcmil		m	ft	
3	4	5	21.6	25	30	8	8	18	100	330	20 (20)
3	5.5	7.5	29.1	40	40	8	8	24	100	330	20 (20)
4	7.5	10	36.4	50	50	16	5	30	100	330	22 (22)
4	11	15	55.8	63	70	16	5	46	100	330	22 (22)
5	15	20	70.2	80	90	35	2	61	100	330	12 (12)
5	18.5	25	82.9	100	110	35	2	72	100	330	12 (12)

18.3.3. 380 – 480 Volt 3 Phase Input

Frame Size	Power Rating		Input Current A	Fuse or MCB (Type B)		Maximum Cable Size		Rated Output Current A	Maximum Motor Cable Length		Recommended Brake Resistance (Minimum) Ω
	kW	HP		Non UL	UL	mm	AWG/kcmil		m	ft	
2	4	5	11.2	16	15	8	8	9.5	100	330	100 (50)
3	5.5	7.5	19	25	25	8	8	14	100	330	75 (40)
3	7.5	10	21	25	30	8	8	18	100	330	50 (40)
3	11	15	28.9	40	40	8	8	24	100	330	40 (40)
4	15	20	37.2	50	50	16	5	30	100	330	22 (22)
4	18.5	25	47	63	60	16	5	39	100	330	22 (22)
4	22	30	52.4	63	70	16	5	46	100	330	22 (22)
5	30	40	63.8	80	80	35	2	61	100	330	12 (12)
5	37	50	76.4	100	100	35	2	72	100	330	12 (12)

Note

- Ratings shown above apply to 40°C ambient temperature. For derating information, refer to section 18.5
- The maximum motor cable length stated applies to using a shielded motor cable. When using an unshielded cable, the maximum cable length limit may be increased by 50%. When using the Invertek Drives recommended output choke, the maximum cable length may be increased by 100%
- The PWM output switching from any inverter when used with a long motor cable length can cause an increase in the voltage at the motor terminals, depending on the motor cable length and inductance. The rise time and peak voltage can affect the service life of the motor. Invertek Drives recommend using an output choke for motor cable lengths of 50m or more to ensure good motor service life
- For UL compliant installation, use Copper wire with a minimum insulation temperature rating of 70°C, UL Class CC or Class J Fuses

18.4. Additional Information for UL Approved Installations

Optidrive P2 is designed to meet the UL requirements. In order to ensure full compliance, the following must be fully observed.

Input Power Supply Requirements				
Supply Voltage	380 – 480 Volts for 400 Volt rated units, + / - 10% variation allowed, Maximum 500 Volts RMS			
Imbalance	Maximum 3% voltage variation between phase – phase voltages allowed			
	All Optidrive P2 Elevator drives have phase imbalance monitoring. A phase imbalance of > 3% will result in the drive tripping. For input supplies which have supply imbalance greater than 3% (typically the Indian sub- continent & parts of Asia Pacific including China) Invertek Drives recommends the installation of input line reactors. Alternatively, the drives can be operated as a single phase supply drive with 50% derating.			
Frequency	50 – 60Hz + / - 5% Variation			
Short Circuit Capacity	Voltage Rating	Min kW (HP)	Max kW (HP)	Maximum supply short-circuit current
	230V/400V	0.75 (1)	37 (50)	100kA rms (AC)
	All the drives in the above table are suitable for use on a circuit capable of delivering not more than the above specified maximum short-circuit Amperes symmetrical with the specified maximum supply voltage.			
Incoming power supply connection must be according to section 6.3.1				
All Optidrive P2 Elevator drives are intended for indoor installation within controlled environments which meet the condition limits shown in section 18.1				
Branch circuit protection must be installed according to the relevant national codes. Fuse ratings and types are shown in section 18.3				
Suitable Power and motor cables should be selected according to the data shown in section 18.3				
Power cable connections and tightening torques are shown in section 5 and 6.				
Optidrive P2 Elevator drives provide motor overload protection in accordance with the National Electrical Code (US).				
<ul style="list-style-type: none"> Where a motor thermistor is not fitted, or not utilised, Thermal Overload Memory Retention must be enabled by setting P4-12 = 1 Where a motor thermistor is fitted and connected to the drive, connection must be carried out according to the information shown in section 6.6.2 				

18.5. Derating Information

Derating of the drive maximum continuous output current capacity is required when:

- Operating at ambient temperature in excess of 40°C / 104°F for enclosed drives (non UL approved)
- Operating at Altitude in excess of 1000m/ 3281 ft
- Operation with Effective Switching Frequency higher than the minimum setting

The following derating factors should be applied when operating drives outside of these conditions

18.5.1. Derating for Ambient Temperature

Enclosure Type	Maximum Temperature Without Derating (UL Approved)	Derate by	Maximum Permissible Operating Ambient Temperature with Derating (Non UL Approved)
IP20	50°C / 122°F	N/A	50°C

18.5.2. Derating for Altitude

Enclosure Type	Maximum Altitude Without Derating	Derate by	Maximum Permissible (UL Approved)	Maximum Permissible (Non-UL Approved)
IP20	1000m / 3281ft	1% per 100m / 328 ft	2000m / 6562 ft	4000m / 13123 ft

18.5.3. Derating for Switching Frequency

Enclosure Type	Switching Frequency (Where available)					
	4kHz	8kHz	12kHz	16kHz	24kHz	32kHz
IP20	N/A	N/A	20%	30%	40%	50%

18.5.4. Example of applying Derating Factors

An 11kW, 380-480V drive is to be used at an altitude of 2000 metres above sea level, with 12 kHz switching frequency and 45°C ambient temperature.

From the Output and Current ratings table 18.3.3, we can see that the rated current of the drive is 24 Amps at 40°C,

1. Apply the switching frequency derating, 12kHz, 20% derating : 24 Amps x 80% = **19.2 Amps**
2. Now apply the derating for altitude above 1000 metres, 1% per 100m above 1000m :
 - a. = 10 x 1% = 10%
 - b. 19.2 Amps x 90% = **17.23 Amps** continuous current available.

If the required motor current exceeds this level, it will be necessary to either

- Reduce the switching frequency selected
- Use a higher power rated drive and repeat the calculation to ensure sufficient output current is available.

18.6. Energy Efficiency Classification

Please scan the QR code or visit www.invertekdrives.com/ecodesign to learn more about the Ecodesign Directive and for specific product efficiency classification and part load loss data in accordance with IEC 61800-9-2:2017



19. Troubleshooting

19.1. Fault messages

Fault Code	No.	Description	Corrective Action
no-FLt	00	No Fault	Displayed in P0-13 if no faults are recorded in the log
01-b	01	Brake channel over current	Ensure the connected brake resistor is above the minimum permissible level for the drive – refer to the ratings shown in section 18.3. Check the brake resistor and wiring for possible short circuits.
0L-br	02	Brake resistor overload	The drive software has determined that the brake resistor is overloaded (based on the values entered in P3-13 and P3-14), and trips to protect the resistor. Always ensure the brake resistor is being operated within its designed parameter before making any parameter or system changes. To reduce the load on the resistor, increase deceleration time, reduce the load inertia or add further brake resistors in parallel, observing the minimum resistance value for the given drive.
0-I	03	Instantaneous over current on drive output. Excess load on the motor.	Fault Occurs on Drive Enable Check the motor and motor connection cable for phase – phase and phase – earth short circuits. Check the load mechanically for a jam, blockage or stalled condition Ensure the motor nameplate parameters are correctly entered, P1-07, P1-08, P1-09. If operating in Vector mode (P4-01 – 0 or 1), also check the motor power factor in P4-05 and ensure an autotune has been successfully completed for the connected motor. If operating in Enhanced V/F mode reduce the Boost voltage setting in P1-11 Increase the ramp up time in P1-03 If the connected motor has a holding brake, ensure the brake is correctly connected and controlled, and is releasing correctly. If operating a Gearless motor Check the encoder offset is correct, see section 12.7. On Gearless closed loop system with motor rated frequency >32Hz or open loop Gearless system ensure the motor back EMF voltage is correct, see section 12.4. Fault Occurs When Running If operating in Vector mode (P4-01 – 0 or 1, 3), reduce the speed loop gain in P4-03.
1.t-trP	04	Drive has tripped on overload after delivering >100% of value in P1-08 for a period of time.	Check to see when the decimal points are flashing (drive in overload) and either increase acceleration rate or reduce the load. Check motor cable length is within the limit specified for the relevant drive in section 18.3 Ensure the motor nameplate parameters are correctly entered in P1-07, P1-08, and P1-09 If operating in Vector mode (P4-01 – 0 or 1), also check the motor power factor in P4-05 and ensure an autotune has been successfully completed for the connected motor. Check the load mechanically to ensure it is free, and that no jams, blockages or other mechanical faults exist If operating a Gearless motor Check the encoder offset is correct, see section 12.7. On Gearless closed loop system with motor rated frequency >32Hz or open loop Gearless system ensure the motor back EMF voltage is correct, see section 12.4.
P5-trP	05	Instantaneous over current on drive output.	Refer to fault 3 above
0-volt	06	Over voltage on DC bus	Check that the lift has been correctly balanced. Check that a brake resistor is connected correctly. (see section 6.4) Check the resistance of the brake resistor complies with the values in section 18.3. If the fault occurs on stopping or during deceleration, increase the deceleration time in P1-04 If operating in Vector Mode (P4-01 = 0-3), reduce the speed loop gain P4-03. Check that the mains voltage level is within the range detailed in section 18.2.1 The value of the DC Bus Voltage can be displayed in P0-20 A historical log is stored at 256ms intervals prior to a trip in parameter P0-36
U-volt	07	Under voltage on DC bus	This occurs routinely when power is switched off. If it occurs during running, check the incoming supply voltage, and all connections into the drive, fuses, contactors etc. If in rescue mode confirm that the voltage is within the range detailed in section 18.2.2 If in rescue mode try decreasing rescue speed (P2-05)
0-t	08	Heatsink over temperature	The heatsink temperature can be displayed in P0-21. A historical log is stored at 30 second intervals prior to a trip in parameter P0-38 Check the drive ambient temperature Ensure the drive internal cooling fan is operating Ensure that the required space around the drive as shown in sections 5.5 and Error! Reference source not found. has been observed, and that the cooling airflow path to and from the drive is not restricted Reduce the effective switching frequency setting in parameter P2-24 Reduce the load on the motor / drive
U-t	09	Under temperature	Trip occurs when ambient temperature is less than -10°C. The temperature must be raised over -10°C in order to start the drive.
P-dEF	10	Factory Default parameters have been loaded	Press STOP key, the drive is now ready to be configured for the required application
E-trIP	11	External trip	E-trip requested on control input terminals. Some settings of P1-13 require a normally closed contactor to provide an external means of tripping the drive in the event that an external device develops a fault. If a motor thermistor is connected check if the motor is too hot.
SC-0b5	12	Communications Fault	Communications lost with PC or remote keypad. Check the cables and connections to external devices

Fault Code	No.	Description	Corrective Action
F_{LT}-dc	13	Excessive DC Ripple	The DC Bus Ripple Voltage level can be displayed in parameter P0-22 A historical log is stored at 20ms intervals prior to a trip in parameter P0-39 Check all three supply phases are present and within the 3% supply voltage level imbalance tolerance. Reduce the motor load.
P-LoSS	14	Input phase loss trip	Drive intended for use with a 3 phase supply, one input phase has been disconnected or lost.
h₀-I	15	Instantaneous over current on drive output.	Refer to fault 3 above
t_h-FLt	16	Faulty thermistor on heatsink.	Refer to your Invertek Sales Partner.
dARtA-F	17	Internal memory fault.	Parameters not saved, defaults reloaded. Try again. If problem recurs, refer to your IDL Authorised Distributor.
4-20F	18	4-20mA Signal Lost	The reference signal on Analog Input 1 or 2 (Terminals 6 or 10) has dropped below the minimum threshold of 3mA. Check the signal source and wiring to the drive terminals.
dARtA-E	19	Internal memory fault.	Parameters not saved, defaults reloaded. Try again. If problem recurs, refer to your IDL Authorised Distributor.
U-dEF	20	User Parameter Defaults	User Parameter defaults have been loaded. Press the Stop key.
F-Ptc	21	Motor PTC Over Temperature	The connected motor PTC device has caused the drive to trip
FAn-F	22	Cooling Fan Fault	Check and if necessary, replace the drive internal cooling fan
0-hERt	23	Ambient Temperature too High	The measured temperature around the drive is above the operating limit of the drive. Ensure the drive internal cooling fan is operating Ensure that the required space around the drive as shown in sections 5.5 and Error! Reference source not found. has been observed, and that the cooling airflow path to and from the drive is not restricted Increase the cooling airflow to the drive Reduce the effective switching frequency setting in parameter P2-24 Reduce the load on the motor / drive
OUt-F	26	Drive output fault	Drive output fault, Confirm all 3 motor phases are connected, check that output contactors are closing fully, not arcing, or not opening whilst the drive is running. Confirm contactor control connections to the drive are correct.
Sto-F	29	Internal STO circuit Error	Check supply to terminal T12 is >18V, otherwise Refer to your Invertek Sales Partner
Enc-01	30	Encoder Feedback Faults	Encoder communication /data loss
SP-Err	31	(Only visible when an encoder module is fitted and enabled)	Encoder Speed Error. The % error between the estimated (open loop)/measured encoder feedback speed and the actual motor speed is greater than the value set in P6-07. <ul style="list-style-type: none"> Confirm that the speed loop gains have been optimised. In Gearless applications can be caused by excess rollback, see section 13.3. In Gearless applications confirm the encoder offset is correct, see section 12.7. In Geared Open loop applications this can be caused by the motor stalling, check : <ul style="list-style-type: none"> Motor data is correct and an auto-tune has been performed. Magnetising current in P7-04 is not too high. Brake is releasing.
Enc-03	32		Incorrect Encoder PPR count set in parameters
Enc-04	33		Encoder Channel A Fault
Enc-05	34		Encoder Channel B Fault
Enc-06	35		Encoder Channels A & B Fault
Enc-07	36		Encoder Communication loss (check Encoder wiring Connections and that encoder module is pushed fully into the option slot of the drive)
AtF-01	40		Measured motor stator resistance varies between phases. Ensure the motor is correctly connected and free from faults. Check the windings for correct resistance and balance.
AtF-02	41		Measured motor stator resistance is too large. Ensure the motor is correctly connected (motor contactor is closed) and free from faults. Check that the power rating corresponds to the power rating of the connected drive.
AtF-03	42	Autotune Failed	Measured motor inductance is too low. Ensure the motor is correctly connected and free from faults.
AtF-04	43		Measured motor inductance is too large. Ensure motor is correctly connected and free from faults. Check that the power rating corresponds to the power rating of the connected drive.
AtF-05	44		Measured motor parameters are not convergent. Ensure the motor is correctly connected and free from faults. Check that the power rating corresponds to the power rating of the connected drive.
bF-Err	47	Brake Release Monitoring- Warning	Check Brake micro-switches, brake release function and that time set in P6-13 is suitable, see section 14.4 for further details on the "brake release monitoring" function.
bF-Loc	48	Brake Release Monitoring- Lockout	
OUt-Ph	49	Output (Motor) Phase Loss	One or all of the motor output phases is not connected to the drive, check that output contactors are closing fully, not arcing, or not opening whilst the drive is running, and also see P3-18 (Motor connected check).
Sc-F01	50	Modbus comms fault	A valid Modbus telegram has not been received within the watchdog time limit set in P5-06 Check the network master / PLC is still operating, Check the connection cables. Increase the value of P5-06 to a suitable level
Sc-F02	51	CAN Open comms trip	A valid CAN open telegram has not been received within the watchdog time limit set in P5-06 Check the network master / PLC is still operating, Check the connection cables. Increase the value of P5-06 to a suitable level
Sc-F03	52	Communications Option Module Fault	Internal communication to the inserted Communication Option Module has been lost. Check the module is correctly inserted

Fault Code	No.	Description	Corrective Action
5c-F04	53	IO card comms trip	Internal communication to the inserted Option Module has been lost. Check the module is correctly inserted

20. User Settings Table.

Par	Parameter Name	Default	User
P1-01	Maximum Frequency / Speed Limit	50.0 (60.0)	
P1-02	Minimum Frequency / Speed Limit	0.0	
P1-03	Acceleration Ramp Time	2.0	
P1-04	Deceleration Ramp Time	2.0	
P1-07	Motor Rated Voltage/Back EMF-PM Motors	-	
P1-08	Motor Rated Current	-	
P1-09	Motor Rated Frequency	50 (60)	
P1-10	Motor Rated Speed	0	
P1-11	V/F Mode Voltage Boost		
P1-12	Primary Command Source Mode	0	
P1-13	Digital Inputs Function Select	1	
P1-14	Extended Menu Access Code	0	
P2-01	Levelling Speed	5.0	
P2-02	High Speed	50.0	
P2-03	Intermediate Speed	25.0	
P2-04	Inspection Speed	5.0	
P2-05	Rescue Mode Speed (400V drives only)	5.0	
P2-06	High Speed 2	5.0	
P2-07	High Speed 3	1.0	
P2-08	Reserved- Do not use	-	
P2-11	Analog / Digital Output 1 (Terminal 8) Function Select	1	
P2-12	Analog Output 1 (Terminal 8) Format	U 0-10	
P2-13	Analog/Digital Output 2 (Terminal 11) Function Select	0	
P2-14	Analog Output 2 (Terminal 11) Format	U 0-10	
P2-15	User Relay 1 Output (Terminals 14, 15 & 16) Function select	8	
P2-16	Adjustable Threshold 1 Upper Limit (Analog Output 1 / Relay Output 1)	100.0	
P2-17	Adjustable Threshold 1 Lower Limit (Analog Output 1 / Relay Output 1)	0.0	
P2-21	Display Scaling Factor	0.000	
P2-22	Display Scaling Source	0	
P2-24	Effective Switching Frequency	-	
P2-25	2nd Deceleration Ramp Time	0.00	
P2-30	Analog Input 1 (Terminal 6) Format	U 0-10	
P2-31	Analog Input 1 Scaling	100.0	
P2-32	Analog Input 1 Offset	0.0	
P2-33	Analog Input 2 (Terminal 10) Format	U 0-10	
P2-34	Analog Input 2 Scaling	100.0	
P2-35	Analog Input 2 Offset	0.0	
P2-36	Start Mode Select / Automatic Restart	Ed9Er	
P2-37	Keypad Mode Restart Speed	1	
P2-39	Parameter Access Lock	0	
P2-40	Extended Parameter Access Code Definition	101	
P3-01	Acceleration Start Jerk	1.0	
P3-02	Acceleration end Jerk	1.0	
P3-03	Deceleration Start Jerk	1.0	
P3-04	Deceleration end Jerk	1.0	
P3-05	Stopping Jerk	1.0	
P3-06	Output Contactor Closing Time/Run command delay time	0.2	
P3-07	Brake Release time	0.50	
P3-08	Brake Apply Delay	0.20	
P3-09	Brake Apply Speed	0.0	
P3-10	Zero Speed Holding Time on disable	0.2	
P3-11	Short Floor Operation	0	
P3-12	Rescue Operation Function	0	
P3-13	Brake Resistor Resistance	0.0	
P3-14	Brake Resistor Power	0.0	
P3-15	Sheave diameter	0.0	
P3-16	Roping Ratio	1	
P3-17	Gear Ratio	1.0	
P3-18	Motor Connected Check	15	
P3-19	Torque Reduction during stopping	10	

Par	Parameter Name	Default	User
P4-01	Motor Control Mode	0	
P4-02	Motor Parameter Auto-tune Enable	0	
P4-03	Vector Speed Controller Proportional Gain	50.0	
P4-04	Vector Speed Controller Integral Time Constant	0.050	
P4-05	Motor Power Factor Cos ϕ	-	
P4-07	Maximum Motoring Torque Limit	200.0	
P4-09	Generator Mode Max. Torque Limit (Maximum Regenerative Torque)	100.0	
P4-10	V/F Characteristic Adjustment Frequency	0.0	
P4-11	V/F Characteristic Adjustment Voltage	0.0	
P4-12	Thermal Overload Value Retention	0	
P4-13	Output Phase Sequence (Geared (Induction) motors only)	0	
P4-15	Low Speed Proportional Gain	50	
P4-16	Low Speed Integral Gain	0.05	
P4-17	Low Speed Gains Transition Point	0.0	
P5-01	Drive Fieldbus Address	1	
P5-02	CAN Open Baud Rate	500	
P5-03	Modbus RTU Baud Rate	115.2	
P5-04	Modbus Data Format	n-1	
P5-05	Communications Loss Timeout	1.0	
P5-06	Communications Loss Action	0	
P5-07	Fieldbus Ramp Control	0	
P5-08	Fieldbus Process Data Word 4 Output Select	0	
P5-12	Fieldbus Process Data Word 3 Output Select	0	
P5-13	Fieldbus Process Data Word 4 Output Select	0	
P5-14	Fieldbus Process Data Word 3 Output Select	0	
P6-01	Firmware Upgrade Enable	0	
P6-02	Auto thermal management	4kHz	
P6-03	Auto-reset delay time	20	
P6-04	User relay hysteresis band	0.3	
P6-05	Encoder feedback enable	0	
P6-06	Encoder PPR	0	
P6-07	Speed error trip level	10.0	
P6-08	Max speed ref frequency	0	
P6-09	Encoder offset	0.0	
P6-10	Enable PLC operation	0	
P6-11	Brake Release-monitoring terminal Enable	Off	
P6-12	Brake Release- monitoring time	0.5	
P6-13	Brake Release-number of errors before lockout	0	
P6-17	Max Torque limit timeout	0.0	
P6-18	DC injection braking voltage	0.0	
P6-22	Reset cooling fan run-time	0	
P6-23	Reset kWh meter	0	
P6-24	Service time interval	0	
P6-25	Reset service indicator	0	
P6-26	Analog output 1 scaling	100.0	
P6-27	Analog output 1 offset	0.0	
P6-28	P0-80 display value index	0	
P6-29	Save User Parameters as default	0	
P6-30	Level 3 access code	201	
P7-01	Motor Stator Resistance (Rs)	Rating dependant	
P7-02	Motor Rotor resistance (Rr)	Rating dependant	
P7-03	Motor stator inductance (Lsd)	Rating dependant	
P7-04	Motor Magnetising current (Id rms)	Rating dependant	
P7-05	Motor Leakage coefficient (sigma)	Rating dependant	
P7-06	Motor stator inductance (Lsq) – PM motors only	Rating dependant	
P7-07	Enhanced generator control	-	
P7-08	Motor Auto-Pre torque	0	
P7-09	Over voltage current limit	-	
P7-10	System Inertia constant	10	
P7-11	Pulse width minimum limit	-	
P7-12	V/F mode/PM magnetising period	-	
P7-13	Rollback Control Gain	0.0	
P7-14	Low frequency torque boost	0.0	
P7-15	Torque boost frequency limit	0.0	-
P7-17	Rescue Mode P-gain	10	-

User Settings Table.

21.Quick Reference Sheet

21.1. Terminal Functions (default Settings).

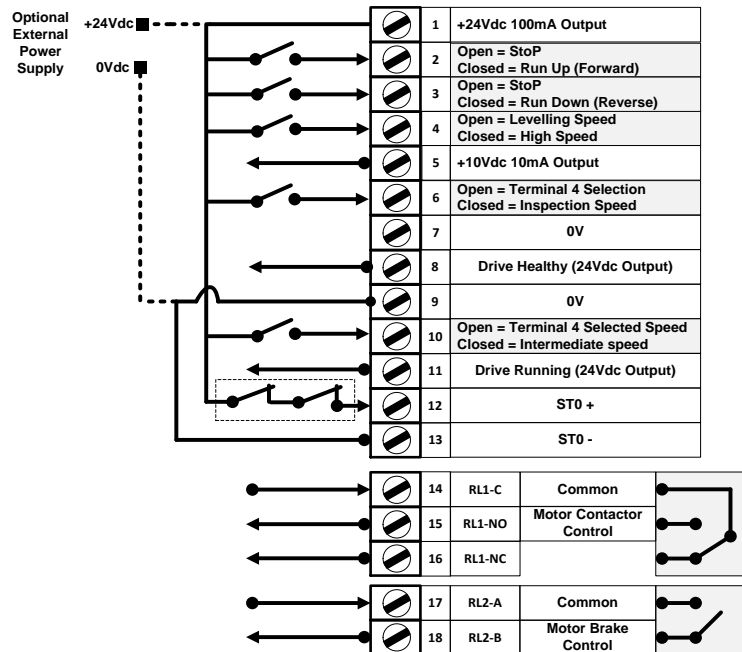

21.2. Speed Profile setup.

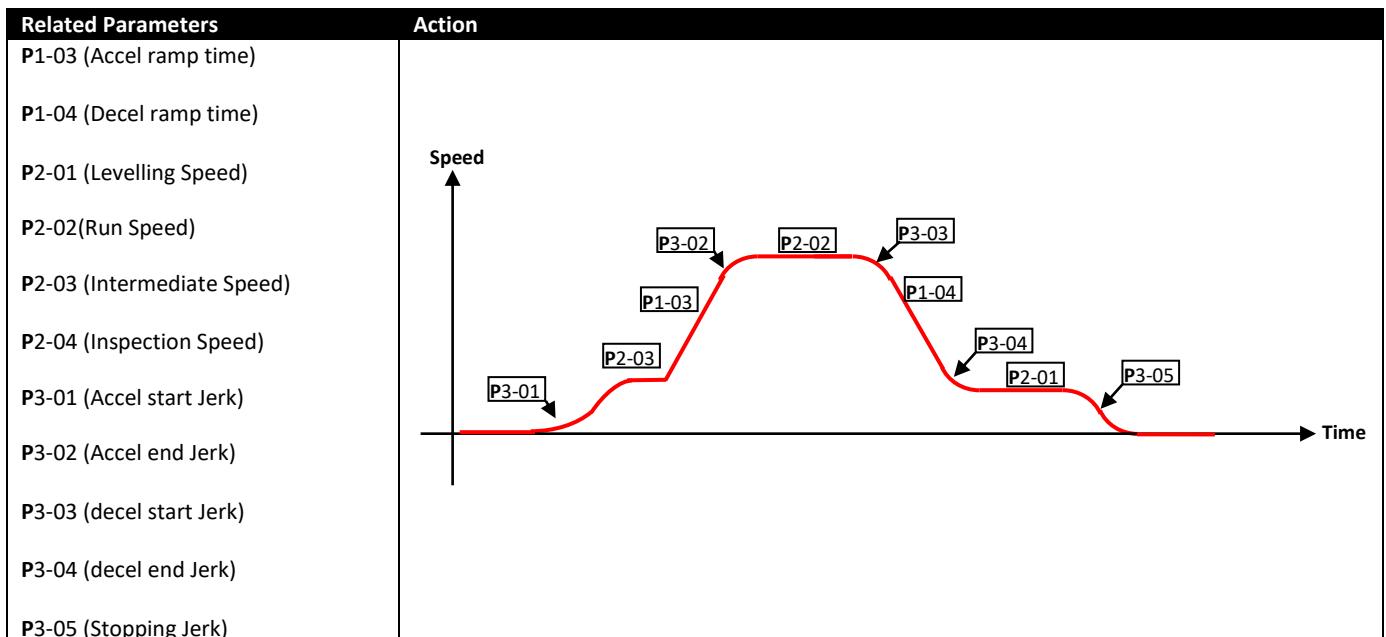

82-OLMAN-IN_V2.30C